

## Interview

Alien Apple Studios

## Articles

Sketchbook of  
Johannes Helgeson

## The Gallery

Markus Lovadina,  
Tiago da Silva,  
plus more!

# 3d artist

Cover Image by Denis Zilber

**Denis Zilber** walks us through the processes he used when he painted the imposing figure of the Loan Shark.

# LOAN \$HARK



## Shoulder Mounted Weapons

We continue the brilliant Designing Weapons series as **Brian Sum** is the latest artist to fire out his designs.



## The Six Realms

Clocking up more miles, we take our fifth journey to a distant realm. **Richard Tilbury** transports us to the Swamp/Marshland Realm.

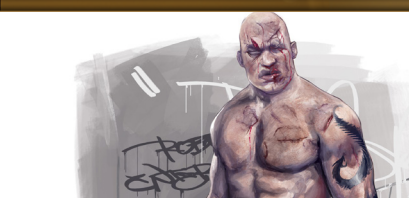

## Custom Brushes for Characters

Things get a little bit violent this month, as **Bart Tiongson** shows us how to paint a Beaten Up Thug.



## Editorial

Welcome to the November issue of *2D Artist*. Yes that's right, November is here, and as the nights are getting darker, the cold of winter is closing in and firework season is upon us, we bring you an explosive issue, full of exciting tutorials to warm up your creative skills! Things start with a bang this month with our stunning front

cover, a ruthless loan shark that **Denis Zilber** has created for our Cartoon Creation 101 series, in which our artists show us how to design and paint basic cartoon characters.

Next up we bring you another exciting installment from our Weapon Design series, where our artists are demonstrating how to design different weapon concepts to fit in various situations and environments for the games industry. This month talented concept artist **Brian Sum** takes us through the design and concept stage of his shoulder mounted weapons, through to adding textures and the final touches.

In this month's issue we have the penultimate chapter of our Six Realms series, where our artists have been showing us how to design six diverse, fantasy realms from the same world. One of the appeals of many modern computer games is the ability to explore vast worlds created by talented teams of artists and designers. You can wander around, venturing from one realm to another, absorbing impressive landscapes while tackling challenges and enemies of every description. One of the challenges faced by the concept artists working on a game like this is creating a variety of environments that still look consistent design-wise. This time around **Richard Tilbury** takes on the challenge as he describes the painting process behind his jungle realm.

**Bart Tiongson** gets in the ring with our Custom Brushes for Character series this month, as he takes his un-textured character and slaps him with custom brushes to create a beaten up thug. Bart demonstrates how to create the custom brushes and how he uses them to detail his character to get this effect.

In this month's Making Of **Andrei Pervukhin** shows us how he made his image *Hell Saloon*, where there is a twist to the classic western scene.

To top things off we have an interview with talented artists and designers **Stuart** and **Donna Jennett**, who talk about their

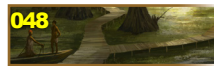
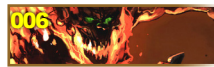

## Contents

What's in this month's issue?

**Alien Apple Studios**  
Interview - Design Studio

**Sketchbook**  
The sketchbook of Johannes Helgeson

**The Gallery**  
10 of the best 2D artworks

**Weapon Design**  
Shoulder Mounted Weapons by Brian Sum

**The Six Realms**  
Swamp/Marshland by Richard Tilbury

**Cartoon Creation 101**  
Loan Shark by Denis Zilber

**Custom Brushes for Characters**  
Beaten Up Thug by Bart Tiongson

**"The Hell Saloon"**  
Project overview by Andrei Pervukhin

**"Red Steam"**  
Digital Art Masters: Volume 7 – Free Chapter

**About Us**  
3DTotal.com Ltd information and contacts

Copyright © 1999-2012 3DTotal.com Ltd. All Rights reserved

All products and websites created/published by 3DTotal.com Ltd including www.3dtotal.com, www.3dcreativemag.com, www.2dartistmag.com all physical books, ebooks, emags, video content, texture libraries and any future releases may not be reproduced in any form or by any means, without the prior written consent of the publisher.

<b>Editor</b> Simon Morse	<b>Layout</b> Az Pishneshin Matthew Lewis	<b>Content</b> Simon Morse Richard Tilbury Jessica Serjent-Tipping	<b>Proofing</b> Jo Hargreaves
<b>Lead Designer</b> Chris Perrins	Layla Khani		<b>Marketing</b> Emma Handley

### Free Stuff!

Wherever you see this symbol, click it to download resources, extras & even movies!



versatile design studio Alien Apple Studios. We also have the sketchbook of brilliant concept artist **Johannes Helgeson**. As if that wasn't enough, we have our usual stunning gallery, featuring work by **Edvige Faini**, **Nicholas Hong**, **Ivan Kashubo** and lots more talented artists.

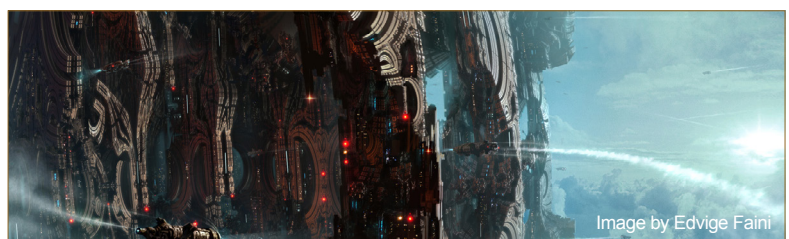

Image by Edvige Faini

adutai.com

Interview  
Alien Apple Studios

Articles  
Sketchbook of  
Johannes Helgeson

The Gallery  
Markus Lovadina,  
Tiago da Silva,  
plus more!

Digital Painting Magazine  
Issue 083 November 2012

2d  
Artist

Denis Zilber walks us through the processes he used when he painted the imposing figure of the Loan Shark.

# LOAN \$HARK

**Shoulder Mounted Weapons**  
We continue the brilliant Designing Weapons series as **Brian Sum** is the latest artist to fire out his designs.

**The Six Realms**  
Clocking up more miles, we take our fifth journey to a distant realm. **Richard Tilbury** transports us to the Swamp/Marshland Realm.

**Custom Brushes for Characters**  
Things get a little bit violent this month, as **Bart Tjongson** shows us how to paint a Beaten Up Thug.

# Get the most out of your Magazine!

If you're having problems viewing the double-page spreads that we feature in this magazine, follow this handy little guide on how to set up your PDF reader!

The Six Realms Chapter 05 - Swamp/Marshland

As the title suggests, this extended look at a digital painting of a swampy forest. The character of the Loan Shark is the central focus of the article, with the artist's work in focus to describe the environment.

In the last featured spread to have the subject matter of a swampy forest, the artist used a variety of techniques to create a sense of depth and atmosphere. In this issue, the artist uses a similar approach to create a sense of depth and atmosphere. In this issue, the artist uses a similar approach to create a sense of depth and atmosphere.

The artist used a variety of techniques to create a sense of depth and atmosphere. In this issue, the artist uses a similar approach to create a sense of depth and atmosphere.

The artist used a variety of techniques to create a sense of depth and atmosphere. In this issue, the artist uses a similar approach to create a sense of depth and atmosphere.

The Six Realms Chapter 05 - Swamp/Marshland

As the title suggests, this extended look at a digital painting of a swampy forest. The character of the Loan Shark is the central focus of the article, with the artist's work in focus to describe the environment.

In the last featured spread to have the subject matter of a swampy forest, the artist used a variety of techniques to create a sense of depth and atmosphere. In this issue, the artist uses a similar approach to create a sense of depth and atmosphere.

The artist used a variety of techniques to create a sense of depth and atmosphere. In this issue, the artist uses a similar approach to create a sense of depth and atmosphere.

The artist used a variety of techniques to create a sense of depth and atmosphere. In this issue, the artist uses a similar approach to create a sense of depth and atmosphere.

## Setting up your PDF reader

For optimum viewing of the magazine it is recommended that you have the latest Acrobat Reader installed.

You can download it for free here: [DOWNLOAD!](#)

To view the many double-page spreads featured in 2DArtist magazine, you can set the reader to display 'two-up', which will show double-page spreads as one large landscape image:

1. Open the magazine in Reader;
2. Go to the **View** menu, then **Page display**;
3. Select **Two-up Continuous**, making sure that **Show Cover Page** is also selected.



### Contributing Artists

Every month many artists from around the world contribute to *3DCreative* and *2DArtist* magazines. Here you can find out a bit more about them! If you would like to be a part of *3DCreative* or *2DArtist* magazine, please contact: [simon@3dtotal.com](mailto:simon@3dtotal.com)

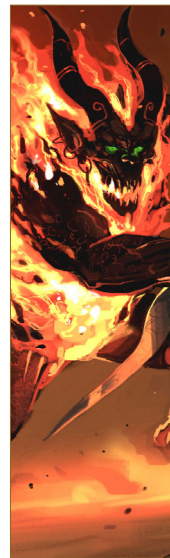

### Stuart & Donna Jennett

Stuart and Donna Jennett are both creative directors at Alien Apple Studios. Stuart is a concept artist and former art director at THQ and Donna is a UI and graphic artist. Alien Apple Studios has been their passion since August 2011.

<http://www.alienapplestudios.com>  
[stuartjennett@hotmail.com](mailto:stuartjennett@hotmail.com)



### Johannes Helgeson

Johannes Helgeson is a freelancing concept artist based in Sweden. He has worked in the game development industry since he graduated from University in 2008. Johannes started taking drawing seriously when he became involved in the [www.conceptart.org](http://www.conceptart.org) community in 2005, and has been practicing as much as possible since then.

<http://helgesonart.blogspot.com>  
[helgesonart@gmail.com](mailto:helgesonart@gmail.com)

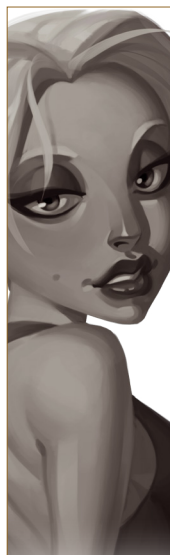

### Brian Sum

Growing up in Vancouver, Canada, Brian was influenced by Japanese anime and Saturday morning cartoons such as *Macross*, *Transformers* and *GI Joe*. After working in Graphic Design and Animation, Brian discovered his true passion in the concept design industry. He is currently a senior concept artist at Bioware, Montreal helping with the *Mass Effect* franchise.

<http://briansum.com/>  
[brian@briansum.com](mailto:brian@briansum.com)



### Richard Tilbury

Richard Tilbury has had a passion for drawing since being a couple of feet tall. He studied Fine Art and was eventually led into the realm of computers several years ago. His brushes have been dissolving in white spirit since the late nineties and his graphics tablet has become their successor. Richard still sketches regularly and now balances his time between 2D and 3D, although drawing will always be closest to his heart.

<http://www.richardtilburyart.com>  
[ibex80@hotmail.com](mailto:ibex80@hotmail.com)



### Denis Zilber

Is a freelance illustrator and animator from Israel. His primary field is mostly digital art, although he's had a great opportunity to study fine arts since he was kid, because both of his parents are also artists. He creates concepts and backgrounds for animated series, character design, illustrations of all kinds and 2D animation. He also does digital sculpting and 3D animation, for self-education.

<http://www.deniszilber.com/>  
[deniszilber@gmail.com](mailto:deniszilber@gmail.com)



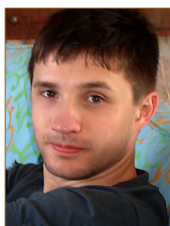

## Andrei Pervukhin

Andrei Pervukhin is a 25 year old Russian artist who in 2007 graduated from the Veronezh art College. Andrei has worked as an illustrator for a Moscow based publisher and does traditional and digital artwork. He has been doing digital artwork for 2 years. In his spare time he enjoys boxing, watching movies and playing computer games.  
<http://pervandr.deviantart.com/gallery/>  
[earfirst@gmail.com](mailto:earfirst@gmail.com)



## Would You Like To Contribute To 3DCreative Or 2DArtist Magazines?

We are always looking for tutorial artists, gallery submissions, potential interviewees, 'making of' writers, and more. For more information, please send a link to your work to: [simon@3dtotal.com](mailto:simon@3dtotal.com)



Image by Nicholas Hong



“Be an artist first and foremost is my best advice. You should live and breathe it. The tools can be learnt; being an artist can’t.”

# ALIEN APPLE STUDIOS

Alien Apple Studios Ltd is a leading conceptual design studio based in the UK, with a creative team that lends their extensive experience to a variety of areas in the industry. In this month's interview Stuart and Donna Jennett talk to us about setting up their own studio, their approach to design and some of the projects they have worked on.

Thanks for taking the time to talk to us. First off could you tell us a little bit about yourselves and how you got started with digital art?

**Donna Jennett:** I started way back in the games business in 1993, using the first version of 3ds Max, so that's real old school I guess, compared to the packages we have now. I'd always had a strong interest in graphic design though and found myself naturally moving more towards UI and HUD design combining a lot of 2D and 3D software, although I did find myself acting as lead artist on *Twin Caliber* which was a fun challenge with such a small team.

During my time at Juice games, THQ and ultimately Alien Apple I've found my main focus definitely lies in the graphics side of things now. I really enjoy the challenge of designing a good brand identity for a project and how that is translated into the final product via the interface, HUD and marketing campaign etc.

**Stuart Jennett:** I started many moons back as a penciller for Marvel UK comics before finding myself working as a storyboard and concept artist in the games industry. My initial introduction to digital art was working in 3D, which I did for many years, providing in-game models for a variety of projects, although I still developed my concept work traditionally on paper. I think once I started using a Wacom tablet I started to feel myself wanting to shift to working digitally throughout the process. I guess it was a speed thing initially and when it came to color work you didn't have to fork out for expensive paints, brushes and art boards. It was all free and you always had the Undo option.

### How did Alien Apple Studios come to be?

**DJ:** After THQ Warrington closed I think we, along with a few of our colleagues, decided working in a studio climate in which you have no control wasn't a place we ever wanted to be again and the thought of setting up our own studio had been playing in the back of our minds for a while. It did take a couple of deep breaths, especially in this current climate, but things are working out OK and we've worked on some great projects so far.

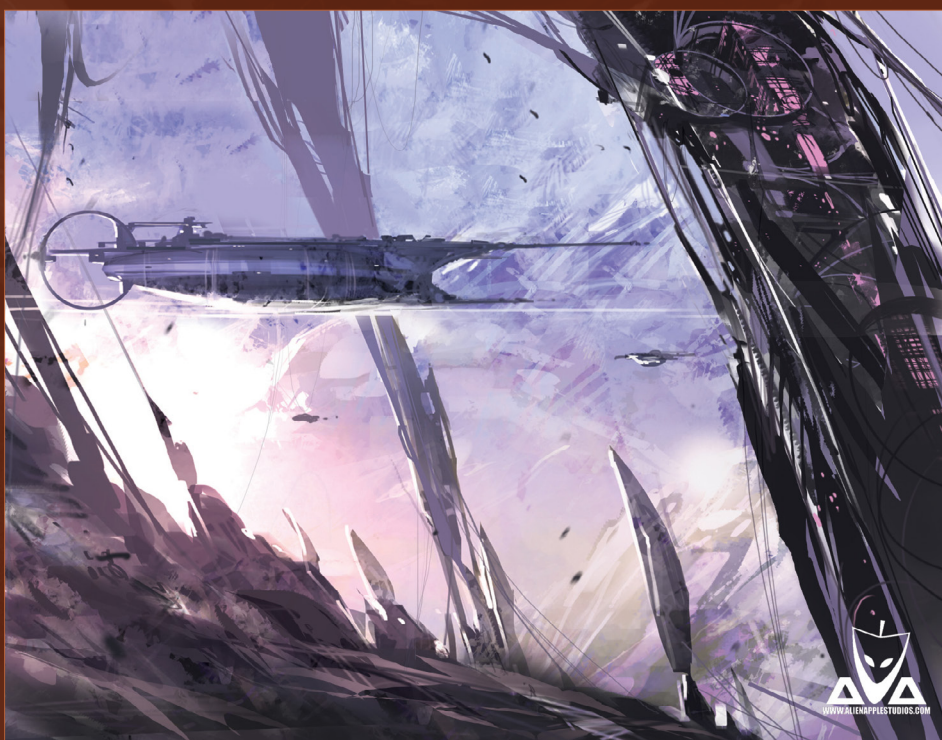

**SJ:** I also missed the freedom I had when I was a freelancer. Going back into a studio as an art director was a big decision for me and to be honest I found the atmosphere slightly restrictive on the creative front. Things seemed bottle-necked at every level and I was tired of having meetings to arrange meetings; I just wanted to keep my hands in on the art side of things. Things are just meant to be sometimes and I do

see the closure of the studio as a blessing, as it's allowed us to open a lot of new doors so far.

**It must have been a huge risk starting the company like that, particularly when you had just seen THQ Warrington close. Why do you think you have been successful in your endeavors so far? And is it liberating being free from a large company like THQ?**



**DJ:** It was a very risky move, as by avoiding going into the employment of another studio you're obviously putting your financial security at risk. With the freedom of working across a broader spectrum of the entertainment industry, it's opened a lot of new opportunities for us and we wouldn't have it any other way now.

**"...it's opened a lot of new opportunities for us and we wouldn't have it any other way now."**

**Do you have any advice for people who want to get into the industry?**

**SJ:** Be an artist first and foremost is my best advice. You should live and breathe it. The tools can be learnt; being an artist can't.

Also the job climate has changed dramatically in this industry over the last few years, with a lot of smaller studios springing up, so the need to be a strong art generalist is imperative – but long term you need to decide early on which particular skill you would like to specialize in.



**Your studio covers a variety of areas; could you tell us a bit about the services you provide?**

**DJ:** We can handle pretty much anything within the concept and design phase, be it character, vehicle or environment design. I personally

specialize in UI (user interface) and graphic design, and can also help with product branding and identity if the client requires it. Stu also likes to do as much illustration/comic work as possible, just to keep him on his toes.



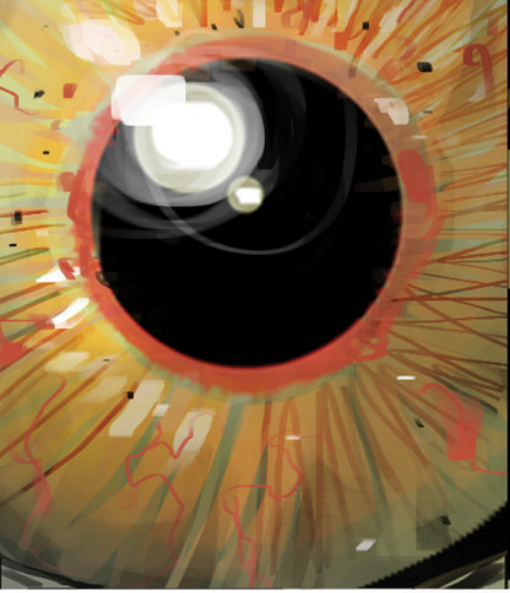



JENNETT 07-  
WWW.STUARTJENNETT.COM



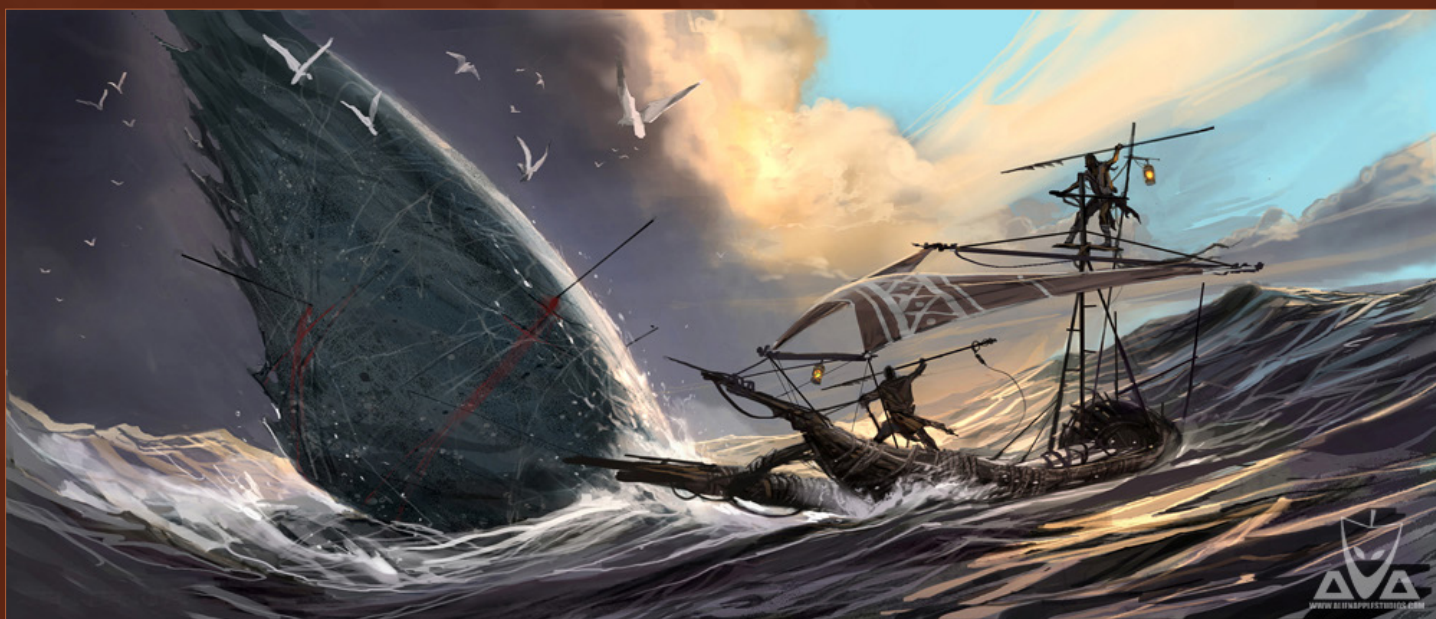

**Do you each have a different style and workflow? Could you tell us a bit about your process?**

**SJ:** I think there's a similar workflow across most disciplines in terms of generating an idea and then how that's refined to a final piece of artwork, regardless of what packages you

use. Obviously Donna's skills are more geared towards the graphics side of things with UI design and general graphics work, whereas I'm more geared towards concept and illustration work. Each involves an initial rough sketch phase to simply get ideas down, and then when the client has picked a favorite we'll run

a number of iterations on that, in terms of finish and presentation, until it has fulfilled the original brief.

**What's your favorite type of design to do?**

**DJ:** I really like getting involved in developing the look and feel of a new IP from the ground



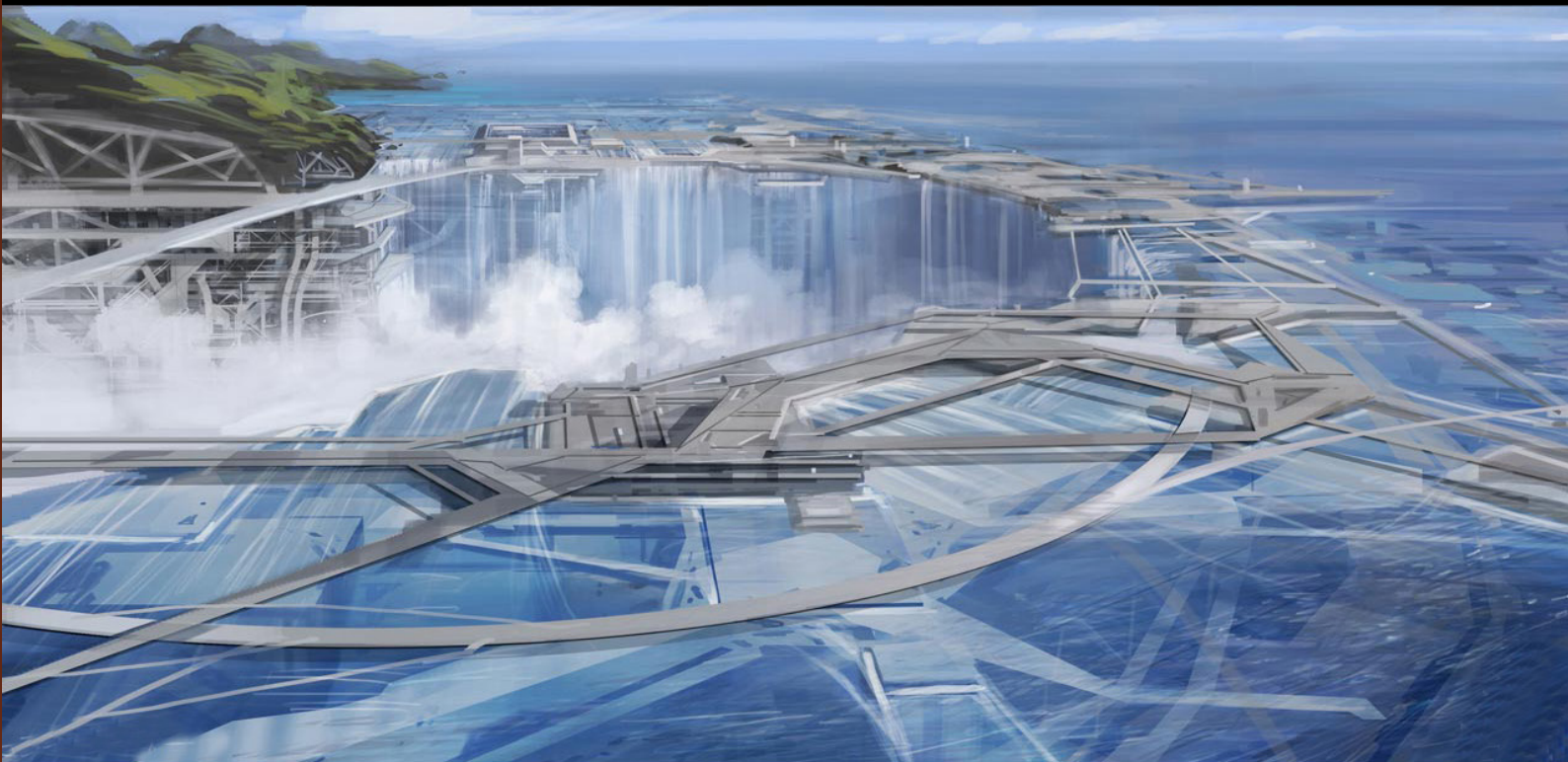
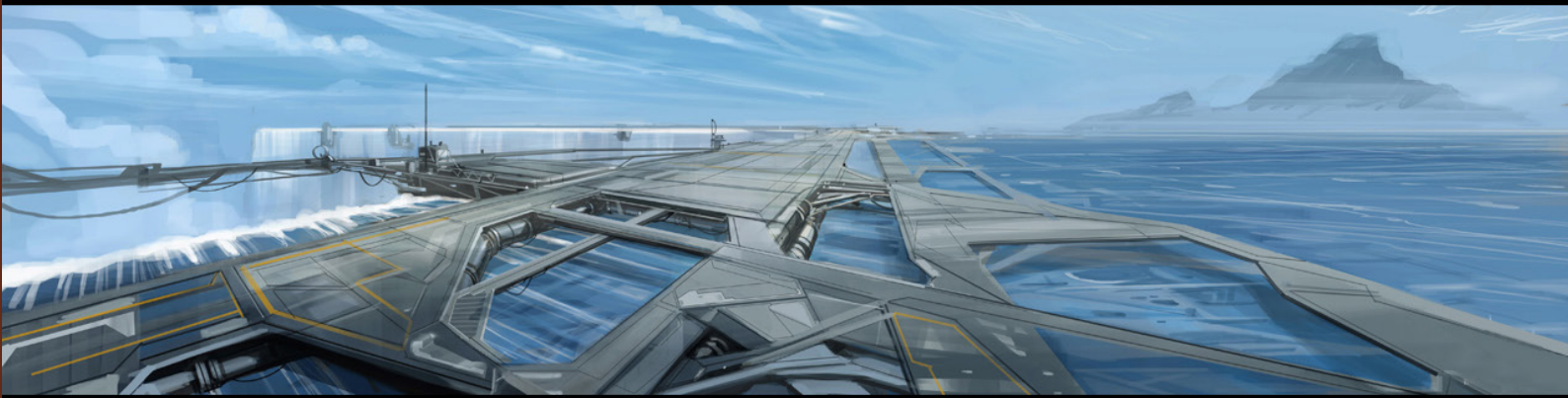

JENNETT 09





up. It means I get involved in all aspects of graphic design as the brand aesthetic develops, be it logo, UI or presentation design.

**SJ:** To be honest I enjoy designing as broad a range of subjects as possible, as each one brings its own set of challenges and helps me to push myself as an artist. I am prone to a little bit of sci-fi military hardware though!

**What's the best project you have worked on and why?**

**SJ:** Personally I've just finished working on the latest James Bond game for Eurocom, which was a good project to get my teeth into and I've also enjoyed working with the guys at Space Digital on a number of projects there. I even found myself storyboarding the title sequence for Gok Wan's new TV show, which was bizarre but fun to do.

**DJ:** I've just finish helping out Bossa Studios with the UI work on the *Merlin* game, which is based on the BBC TV show. I really enjoyed the challenge of that. I've also done a couple of other projects, which still seem to be languishing in development hell; hopefully they'll see the light of day at some point.



**What plans does the studio have for the future?**

**SJ:** Well I think we'd obviously like to grow as a studio a little more. We have some great artists interested in joining us and it's just a matter of the right time really, especially in this climate. We also have an internal project that we're very excited about; it's been in development for a while, but will finally see the light of day early next year. Watch this space.

**Thanks for speaking to us and sharing your brilliant work.**

Thank you, we really enjoyed the interview.

**Alien Apple Studios**

**Web:** <http://www.alienapplestudios.com>

**Email:** [stuartjennett@hotmail.com](mailto:stuartjennett@hotmail.com)

**Interviewed by:** Jessica Serjent-Tipping

Image Courtesy of Ali Zafati



Available at your local reseller  
[Pixologic.com/resellers](http://Pixologic.com/resellers)

"I think there is a lot of appeal in creating something that hasn't been done too much and is unusual in contemporary media."

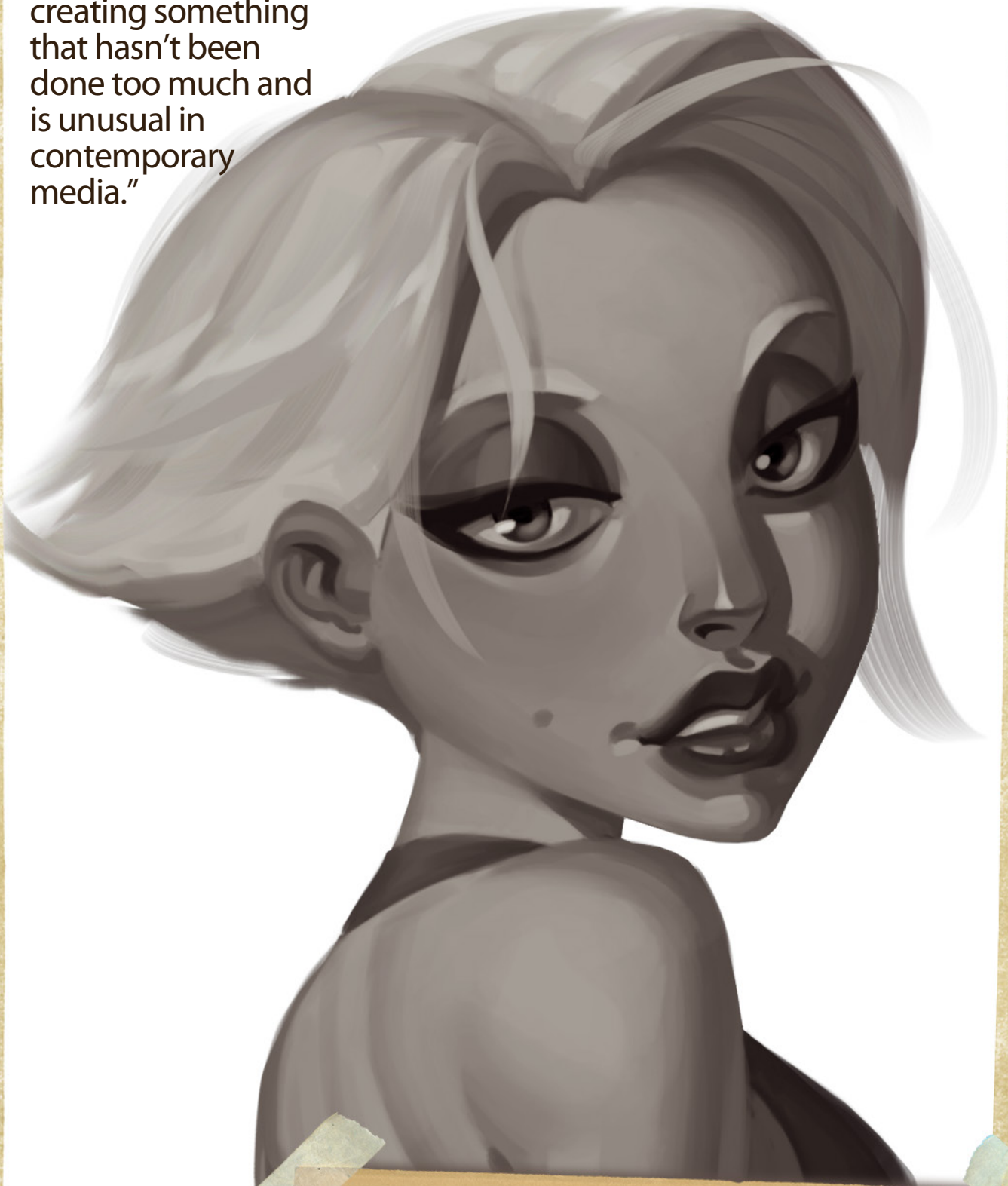

# SKETCHBOOK

## Of Johannes Helgeson

In this month's sketchbook creative concept artist Johannes Helgeson gives us a glimpse into his sketchbook full of exciting and interesting character designs.



## Sketchbook of Johannes Helgeson

I don't hold my own work in high regard, but I respect myself when I'm practicing in order to get better, and making mistakes. I think drawing, designing and painting are very difficult and frustrating endeavors, but ultimately the most fun and satisfying ones I have experienced. I find meaning and take great pleasure in trying to obtain a higher level of skill at my chosen craft.

I have always tried to surround myself with artists better than myself, and keep an inquisitive nature and open mind so I can absorb as much wisdom as possible. I had a great teacher who once told me, "Shut up and listen, young Padawan". Best advice ever. At the same time, it's important to know when to employ critical thinking; there are a lot of "authorities" out there who don't know what they're

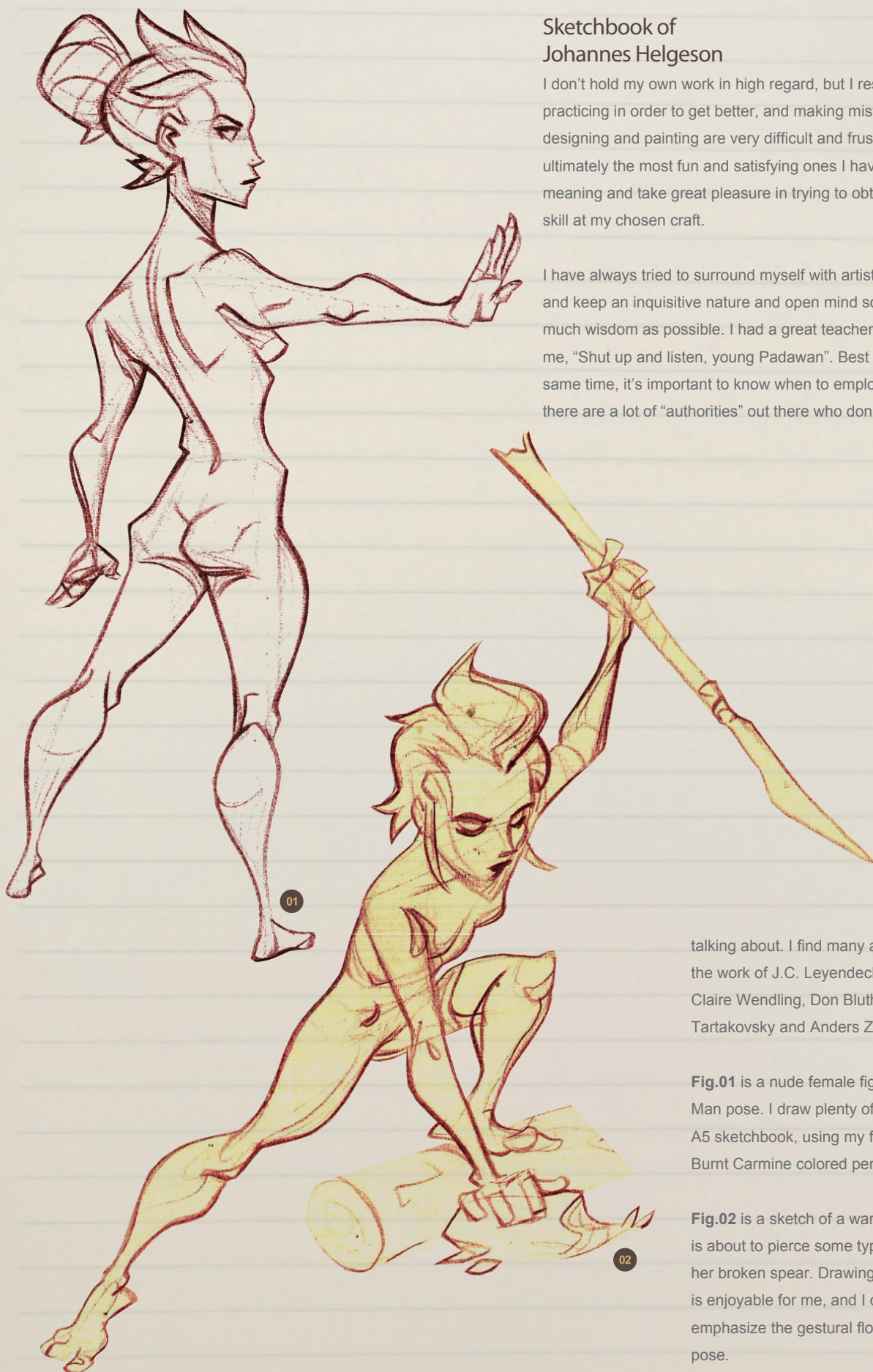

talking about. I find many answers looking at the work of J.C. Leyendecker, Bruce Timm, Claire Wendling, Don Bluth, Milt Kahl, Genndy Tartakovsky and Anders Zorn.

**Fig.01** is a nude female figure doing an Iron Man pose. I draw plenty of these in my moleskin A5 sketchbook, using my favorite Derwent Artist Burnt Carmine colored pencils.

**Fig.02** is a sketch of a warrior woman as she is about to pierce some type of beast with her broken spear. Drawing the female form is enjoyable for me, and I often attempt to emphasize the gestural flow and rhythm of the pose.

In **Fig.03** is a male warrior I sketched for a personal project. He aims for perfection at his chosen craft: walking the earth with his eyes closed as a means of growing faster. The sharp triangular shape is repeated all over in an attempt to tie the design together. Watch out for the beard!

In **Fig.04** you will see a sketched portrait of a character for a personal project. I rarely render on paper; I find it's faster in Photoshop. I think there is a lot of appeal in creating something that hasn't been done too much and is unusual in contemporary media.



**Fig.05** is from a bunch of sketches I did for a Noir pen and paper RPG campaign I'd like to run some day. My interest in drawing was pretty much sparked around the age of 15 when I started playing RPGs with friends. I always visualized my character and the NPCs of the campaign. I still love playing RPGs such as *Drakar och Demoner* (Swedish), *Mutant Chronicles* (cover art by Paul Bonner) and *Vampire The Masquerade*.

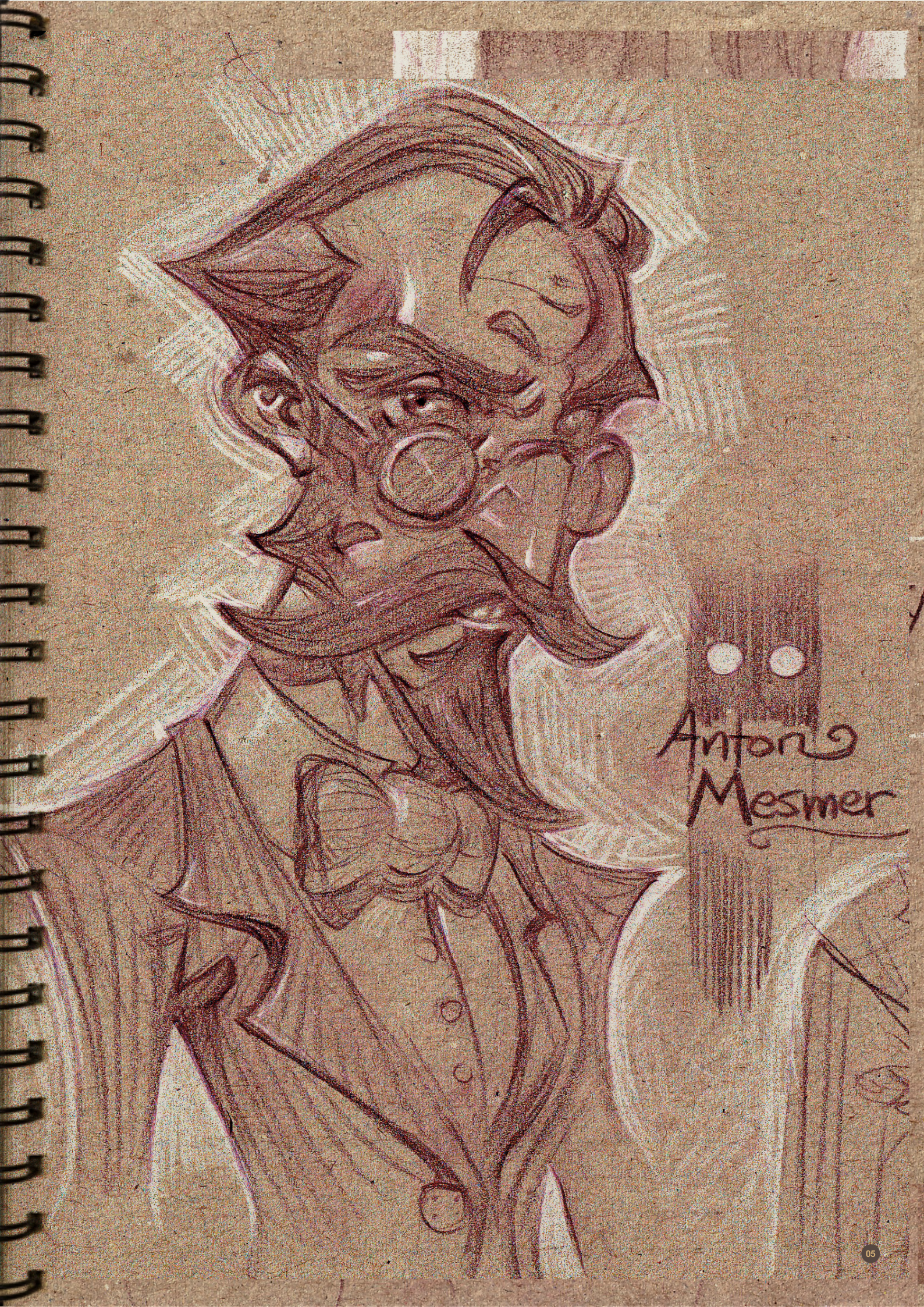

Anton  
Mesmer



Chantel is a character for a pen and paper RPG campaign I'd like to run some day. She's a singer in a film Noir-influenced world, where seduction and manipulation are her weapons of choice. Her physical appearance is inspired by Natalie Portman and Christina Aguilera (**Fig.06**).

Detective Ace is a player character for a pen and paper role-playing campaign. He's a hardboiled detective. Pen and paper role-playing games were a huge contributing factor in making me choose drawing for a living. I was always drawing characters. If I know a character well enough to role-play them, it'll be easier to capture their personality in a drawing (**Fig.07**).

**Fig.08** shows how I often start designing a character: using a colored Burnt Carmine pencil in my A5 moleskin sketchbook. I just explore shapes, personalities, poses, gestural flow and certain features of the design which are unclear to me.



BOISTEROUS COCKY MUSKETEER  
TYPE.

CONFIDENT.

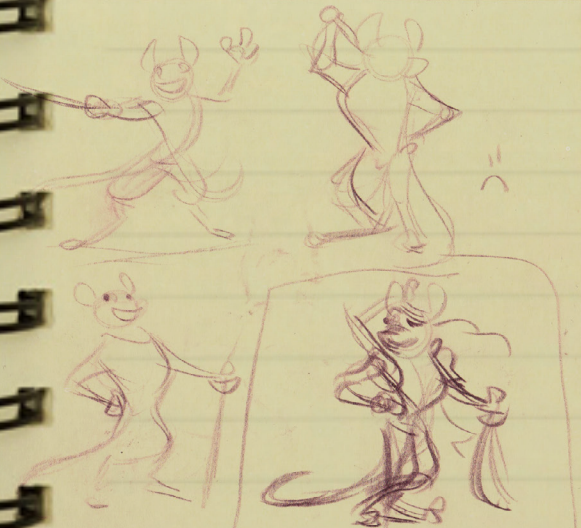
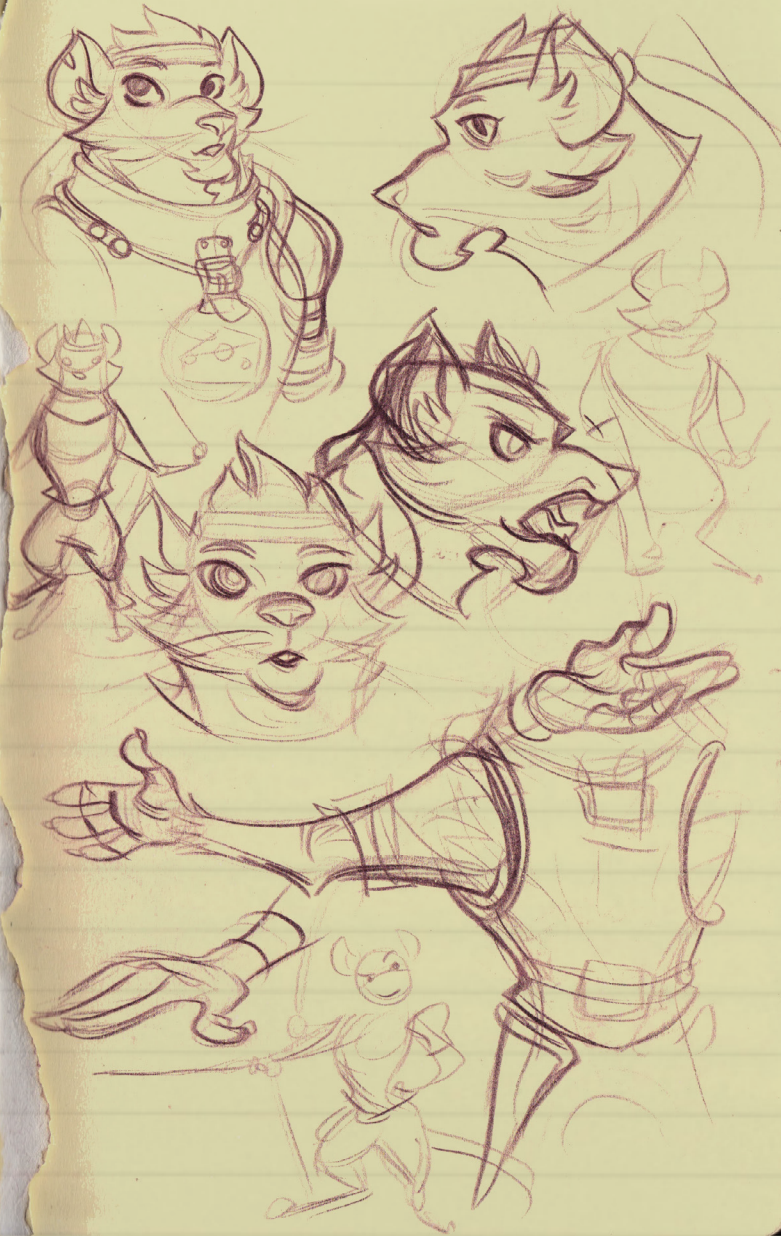

- WEASEL
- FROG
- TURTLE
- BIRD
- BAT
- HEDGEHOG
- RABBIT

- SQUIRREL
- TOAD
- SKUNK



BOISTEROUS,  
CONFIDENT,  
CHARMING.

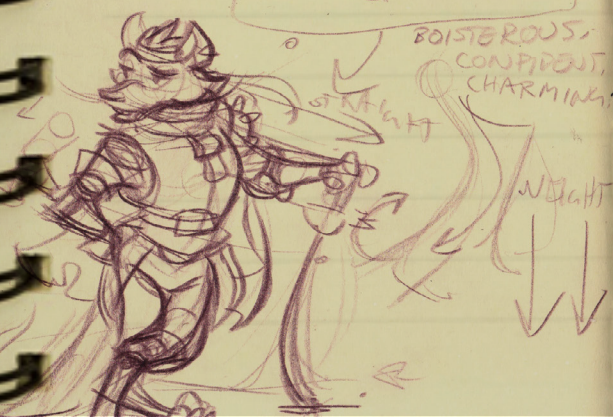

sheet of  
lead



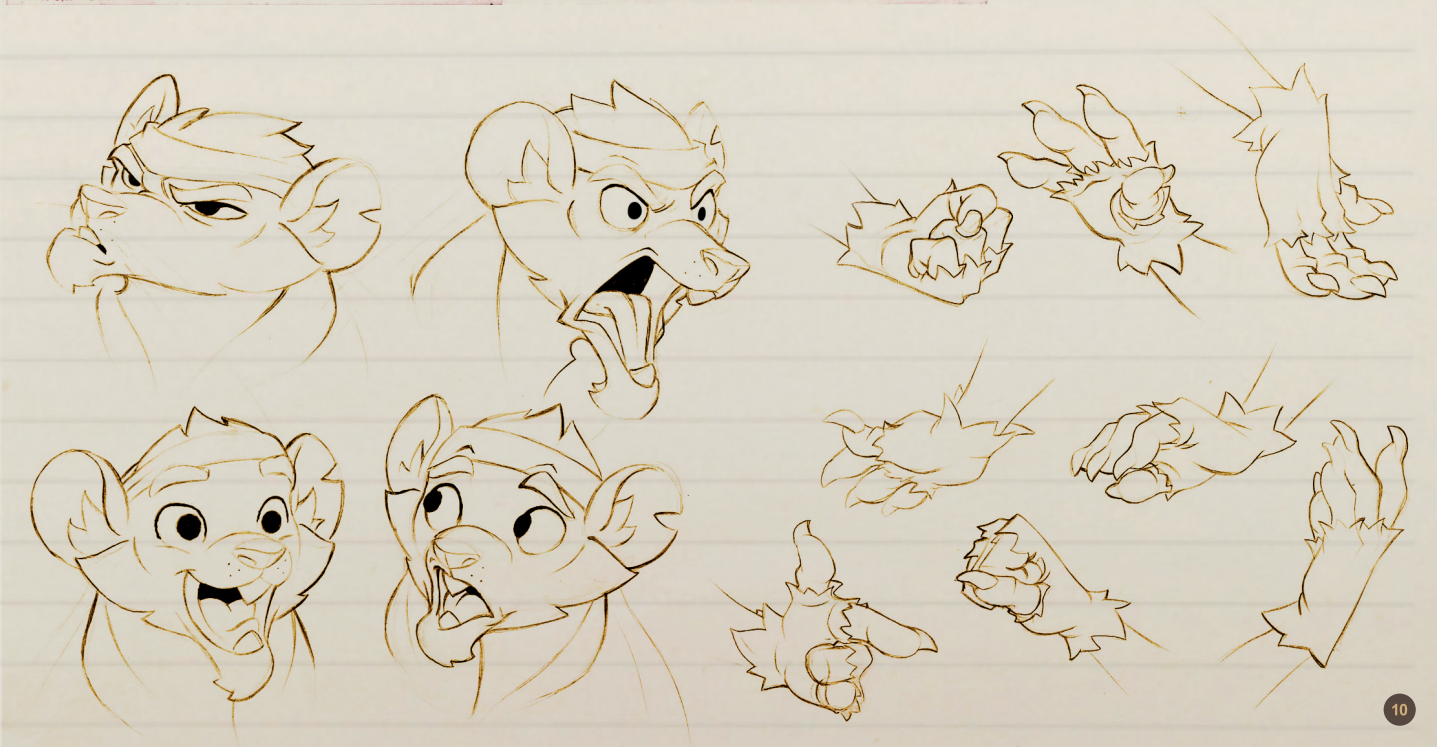
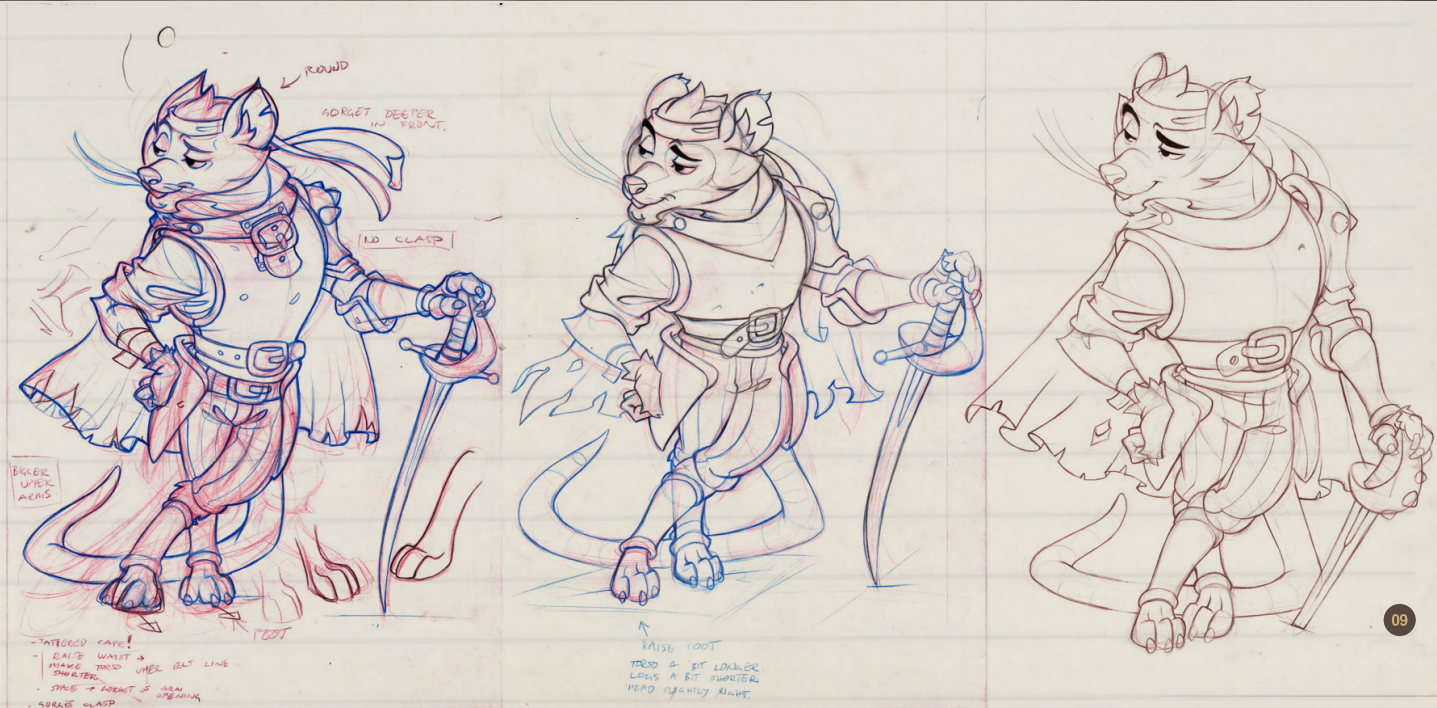

Having done some primary sketches I have a go at drawing the final version. I try and try again until I'm satisfied, or near satisfied. I don't mind making minor changes in Photoshop. Ideally I'd nail the drawing on the first go, but I always realize I haven't thought the design through, or I find design solutions that would work better. I usually need to have a clear vision in my head of what I'm supposed to draw if I'm going to make it look decent. This step is kind of like refining my thoughts and ideas visually (Fig.09).

This is just me having fun once the design is figured out. I treat every expression as a small story, like, "Happy to see a long lost friend", "TO BATTLE!" or "Stretching cautiously for a valuable treasure". I think it's a good way of getting to know the character better. I suppose I'm doing something similar to what an actor would, but in my head (Fig.10).



This guy is a drunken master turtle. I aimed to make him warm, enthusiastic and carefree. He fights with a bottle. I really enjoyed drawing his hands and feet, because of the excess skin going on (Fig.11).

Evil Mage, the arch nemesis, is an elf sorcerer bent on the destruction of the world. This design is a collection of all the bad guy traits I could think of; bald, wickedly smiling, triangular concave shapes, black and purple. All these elements came together in an attempt to create an unmistakable villain (Fig.12).

Crimson Claw is a maniacal forest elf. I had fun turning up her volume to 100%. Beneath the surface there's a lot of construction going on. I draw with tools I primarily picked up from Glenn Vilppu (Fig.13).

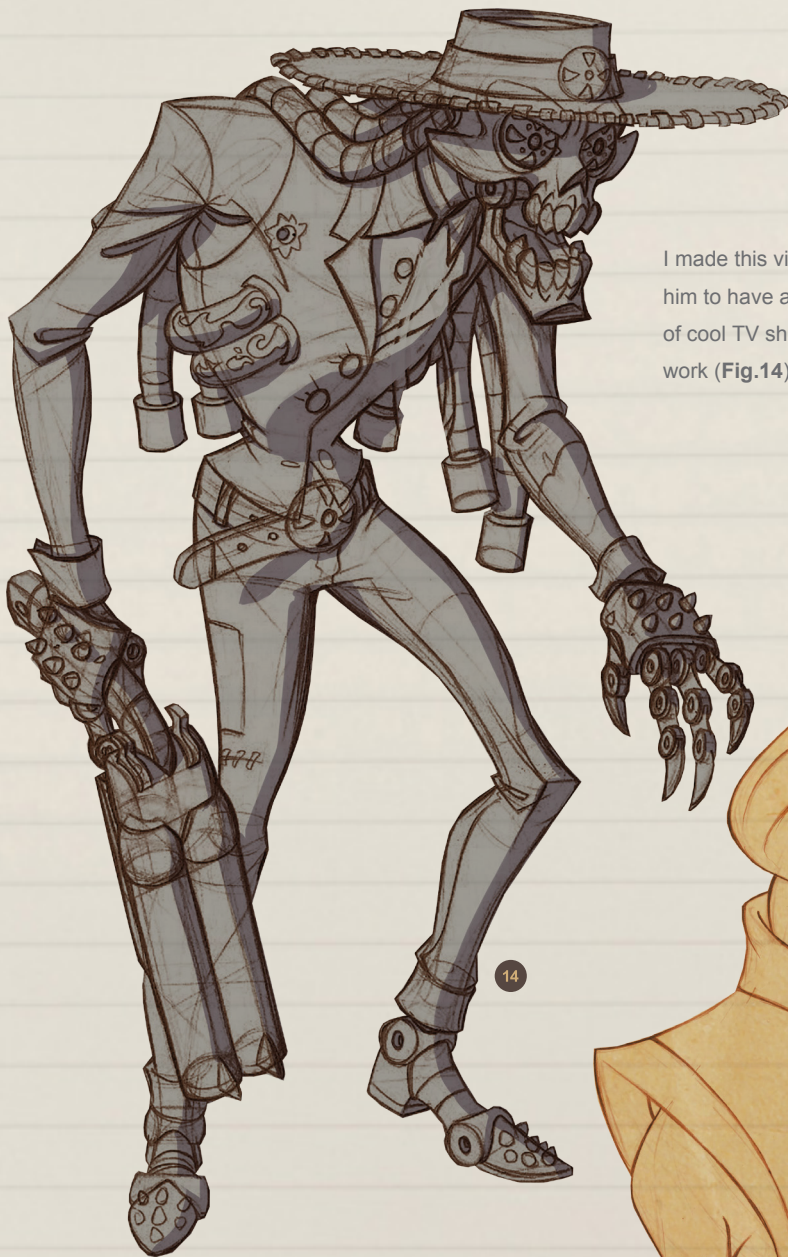

I made this villain for a personal project called Dreadskull. I wanted him to have an 80s cartoon-inspired look. I grew up watching a lot of cool TV shows, and I think they find their way into my current work (Fig.14).

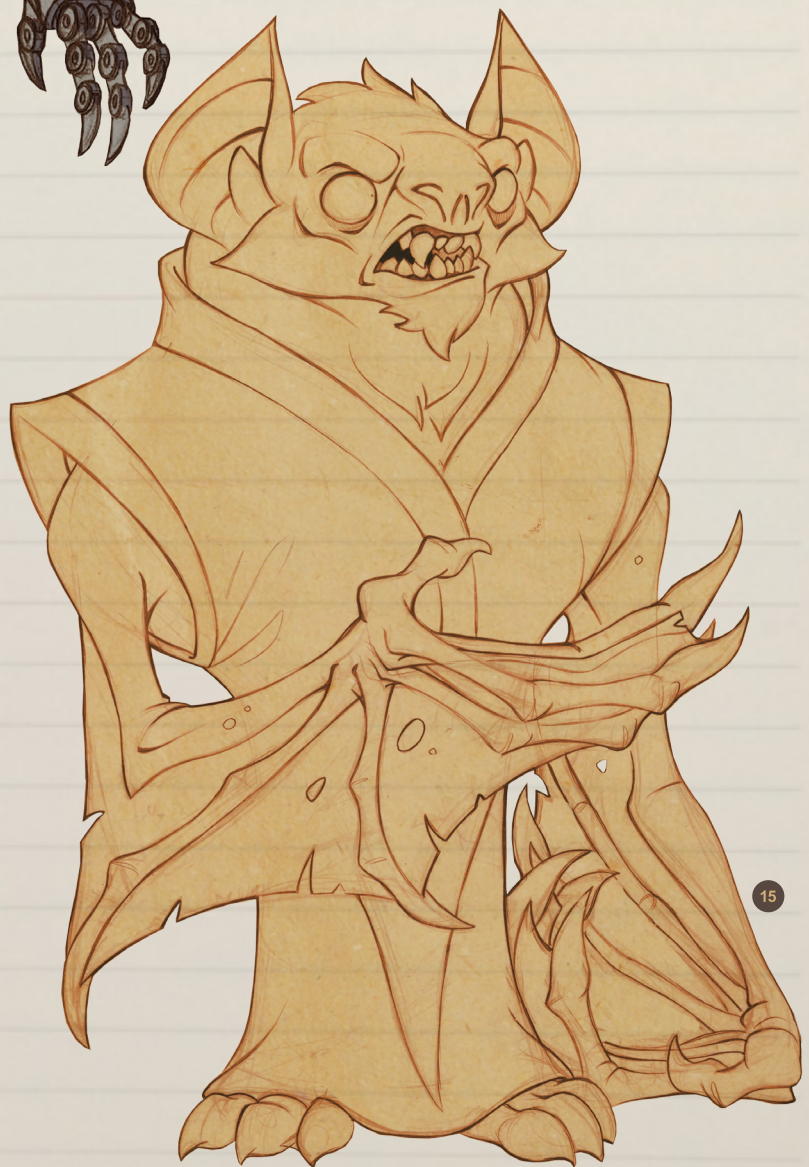

Evil Bat is an evil necromancer bat. Enough said (Fig.15).

Johannes Helgeson

Web: <http://helgesonart.blogspot.com>

Email: [helgesonart@gmail.com](mailto:helgesonart@gmail.com)





# SynthEyes

Match-moving, Set Reconstruction, and Stabilization

**Texture Extraction: clean plates, set modeling, panoramas**  
**New Advanced Lens Grid Analysis and Calibration Tools**

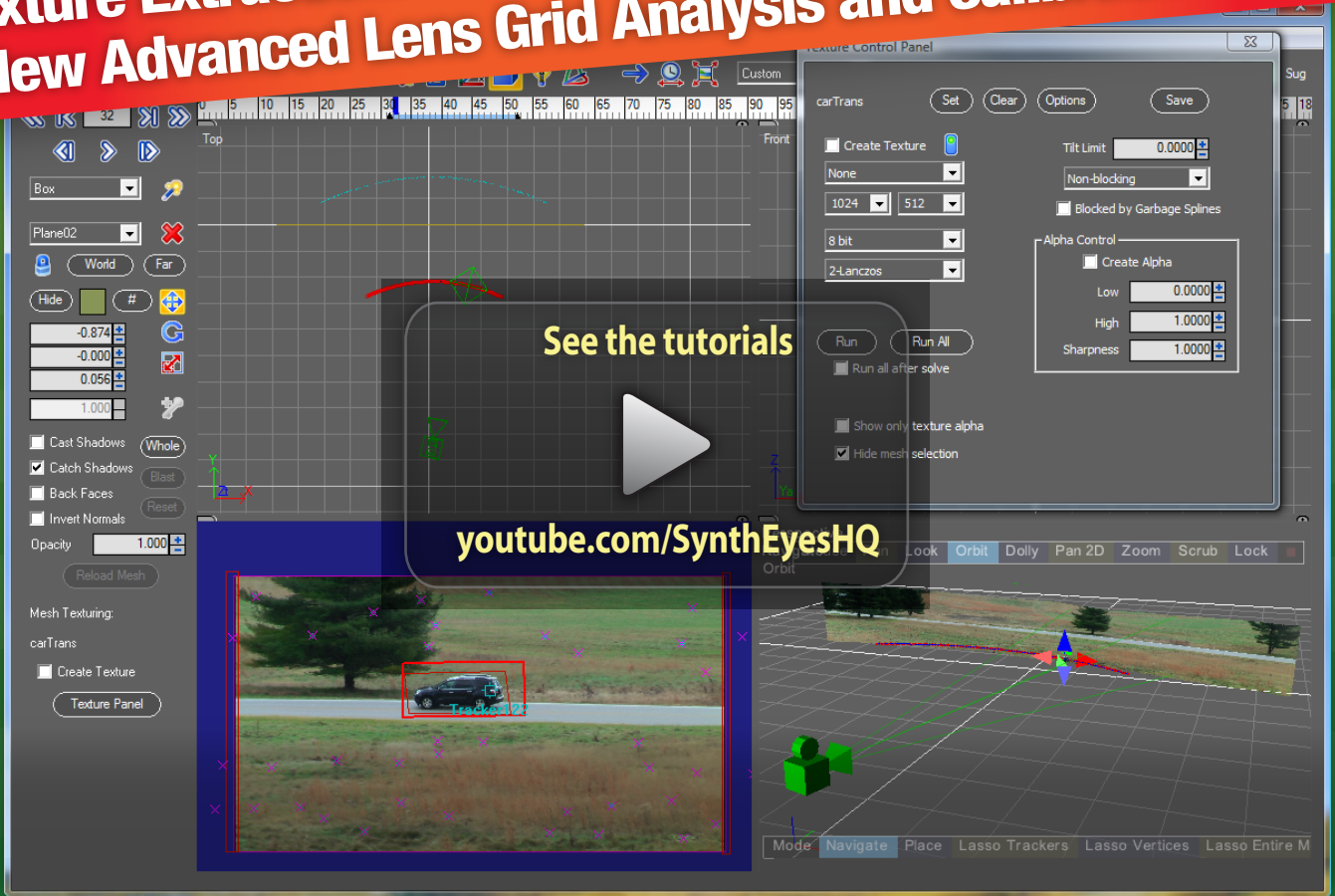

**Sophisticated AfterEffects exporter with Pixel Benders**

**Pro 64-bit version only \$599 for Windows and Mac OS X,  
full-featured entry-level 32-bit version an incredible value at \$399**



## Typical Applications

- Fixing Shaky Shots
- Virtual Set Extensions
- Animated Character Insertion
- Product Placement in Post-Production
- Face & Body Motion Capture
- Talking Animals



## What Our Users Say About SynthEyes

**@willsummers:** @geddy76 I've never used PFHoe but Syntheyes is a really great tracker with all the little professional tools you need to fine tune tracks

**@julikt:** Many people mourn the old Flame 3D tracker but I can work better with Syntheyes on the side on a laptop. With clients in attendance.

**@pete\_shand:** Getting my matchmove on with Syntheyes, so much easier to use than Autodesk's Matchmover.

Andersson Technologies LLC

# ssontech.com

Serving artists in over 70 countries since 2003



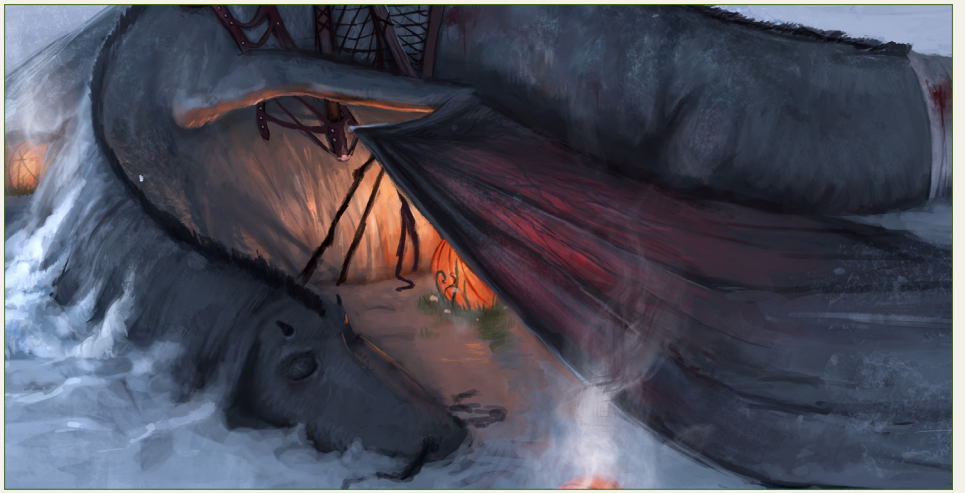
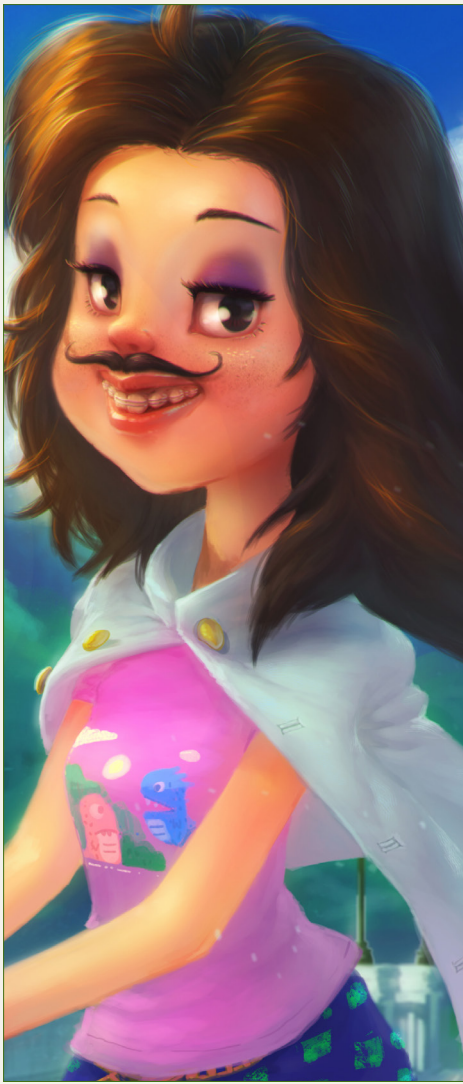

THE

# GALLERY

**This month we feature:** Tiago da Silva | Erphan Malek Hoseiny | Ivan Kashubo | Ghassem Farhany | Aekkarat Sumutchaya  
Nicholas Hong | Markus Lovadina | Oleg Leshiy Shekhovtsov | Maxim Kozlov | Edvige Faini



### Rain

Nicholas Hong

<http://nickong1205.blogspot.ca/>

[nickong1205@gmail.com](mailto:nickong1205@gmail.com)

(Above)

### Floating City

Edvige Faini

<http://www.edvigefaini.com>

[edvige.faini@gmail.com](mailto:edvige.faini@gmail.com)

(Below)



© Edvige Faini





Chase

Markus Lovadina

<http://malosart.blogspot.com>

[malo74@gmx.de](mailto:malo74@gmx.de)





Under The Night Grey Owl

**Tiago da Silva**

<http://grafik.deviantart.com>

[tmds77@hotmail.com](mailto:tmds77@hotmail.com)

(Right)

Thai Style Mix and Match

Aekkarat Sumutchaya

<http://aekkarat.blogspot.com/>

[webang111@gmail.com](mailto:webang111@gmail.com)



Aekkarat

[www.aekkarat.blogspot.com](http://www.aekkarat.blogspot.com)



Grandfather Nurgle

Oleg Leshiy Shekhovtsov

<http://xleshiyx.deviantart.com/>

[art.leshiy@gmail.com](mailto:art.leshiy@gmail.com)







Wyvern

Maxim Kozlov

<http://maximyz.livejournal.com/>

maxkoz@mail.ru



Mech Trooper

Ivan Kashubo

<http://ivankash.blogspot.com/>

[ivankash.art@gmail.com](mailto:ivankash.art@gmail.com)

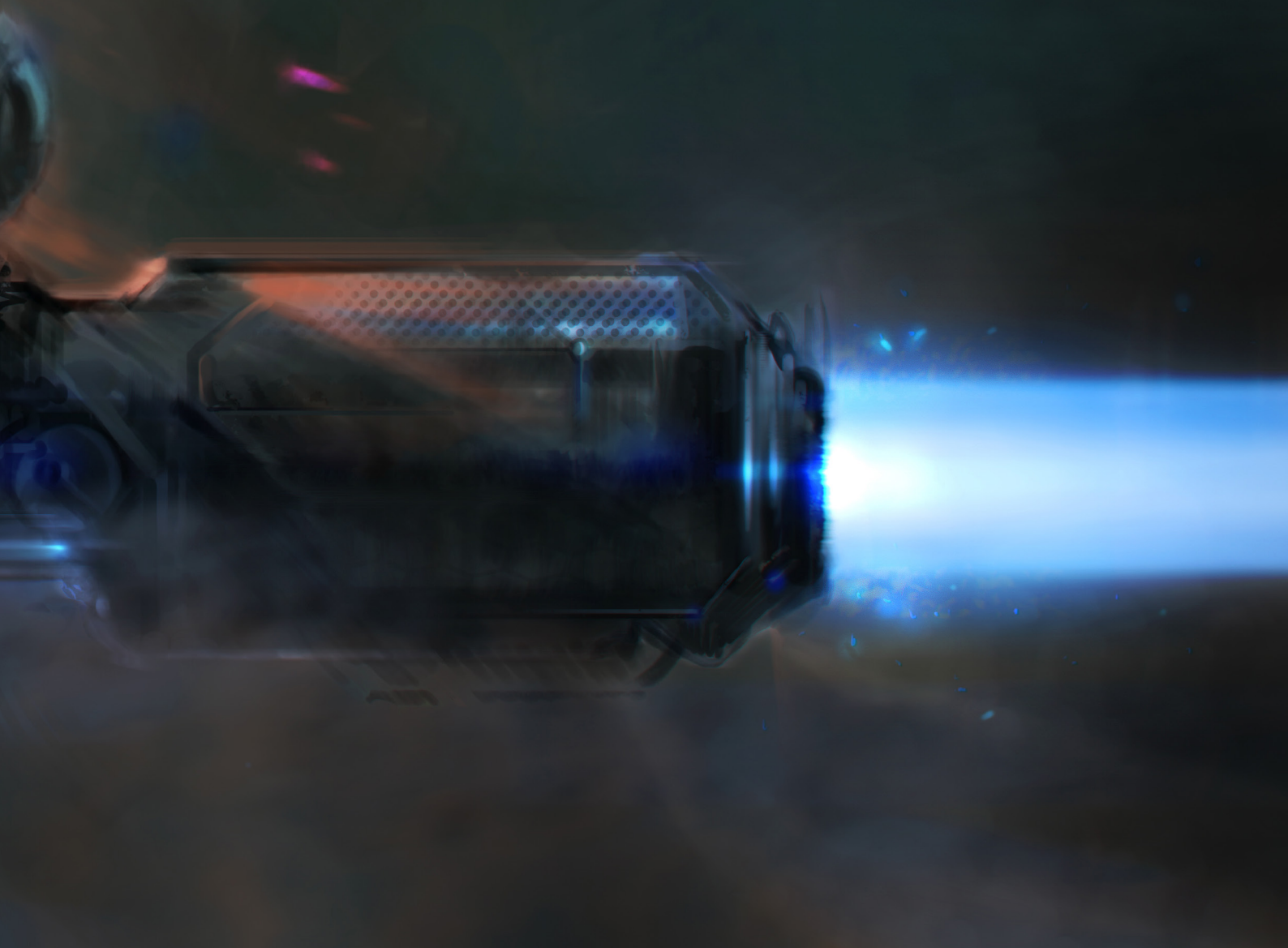



### Jungle's Heart

Ghassem Farhany

<http://www.farhany.blogspot.com>

[gh.farhany@gmail.com](mailto:gh.farhany@gmail.com)

(Above)

### Funky Fighters

Erphan Malek Hoseiny

<http://erphanph.blogspot.com>

[ehsan\\_maleki\\_em@yahoo.com](mailto:ehsan_maleki_em@yahoo.com)

(Below)



# WATCHED A BLOCKBUSTER LATELY?

VFS 25 YEARS

THEN YOU'VE SEEN THE WORK OF VFS ANIMATION & VISUAL EFFECTS GRADS

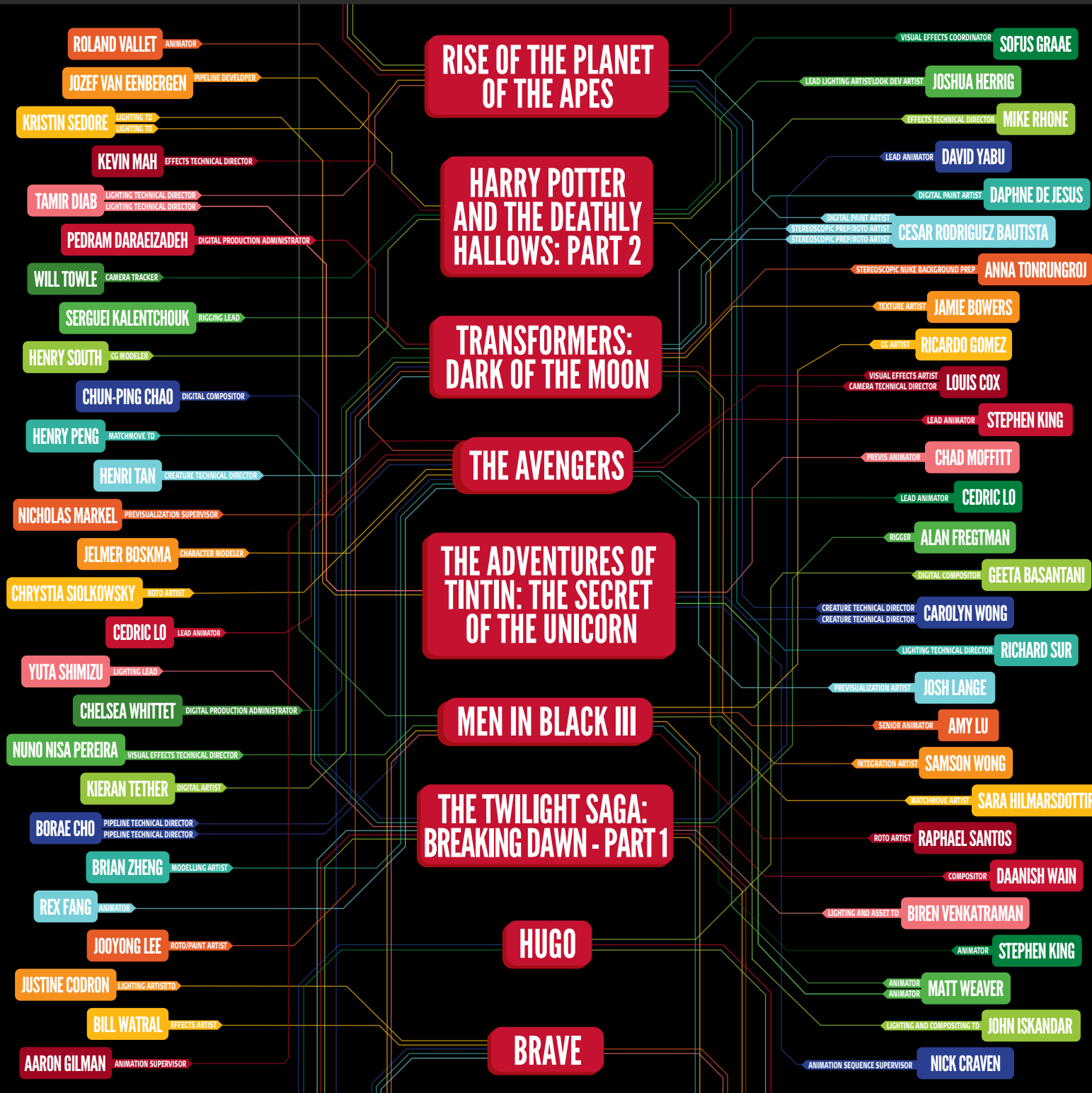

VFS CONNECTS THE ENTERTAINMENT INDUSTRY.

VFS ANIMATION & VISUAL EFFECTS

LEARN MORE AT [VFS.COM/3DTOTAL](http://VFS.COM/3DTOTAL)

CG STUDENT AWARDS  
SCHOOL OF THE YEAR  
2010, 2011 & 2012

# WEAPON DESIGN



★ ★ ★ ★ ★ 03 ★ ★ ★ ★ ★

There are many industries that hold a place for digital art, but none of these rely on it as much as the games industry! Lots of different elements go into making a game, but in many, weaponry is an exciting and integral part of game play. In this tutorial series our artists will be showing us how to create weapon concepts for different situations and environments, as if they were doing it within the games industry. This will involve them coming up with a concept and design, then demonstrating their techniques.



## Chapter 03 – Shoulder Mounted Weapons

Software Used: Photoshop

I chose to do a shoulder mounted weapon for this tutorial, since I've never done one before and I thought it would be a fun challenge. I decided to keep with tradition and design one that would exist in the *Mass Effect* universe. I didn't have a specific design in mind at this point, but I had a general idea of how I wanted to approach this weapon. I wanted to give it a heavy mass, similar to a traditional rocket launcher, but at the same time I wanted to push for a more unique silhouette. I wanted the gun to have elements that were familiar in traditional weapons, while adding a fictional element that wasn't too "wacky" looking.

I always start by looking at as much reference material about the subject matter as I can. In this case I looked at a lot of rocket launchers, as well as fictional weapons to see what's been done already. I'm always conscious of what designs are out there to make sure I don't do something similar.

I start by laying a base figure down to establish where the hand and shoulder placement should be (Fig.01).

Once this is established I start laying down shapes with a default round brush at 100% opacity. I paint a few variations in grayscale with 2-3 tones. I'm not really thinking about color yet. I'm mainly concerned with the shape of the design and the relationship between the different tones. It's really a balancing act.

I toyed with the idea of possibly making it a rail gun of some sort and also with how possible ammo clips could slot in. In the end I decide to go with the bottom version, which has a more traditional cylindrical barrel. I like the silhouette and I think it still has that rocket launcher feel (Fig.02).

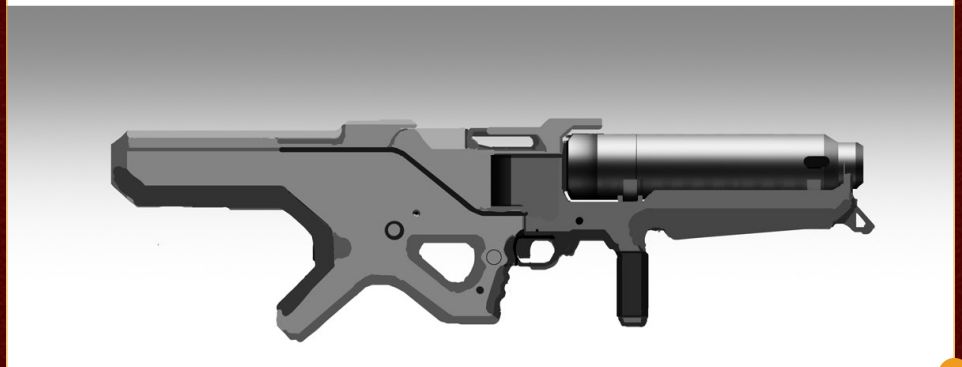
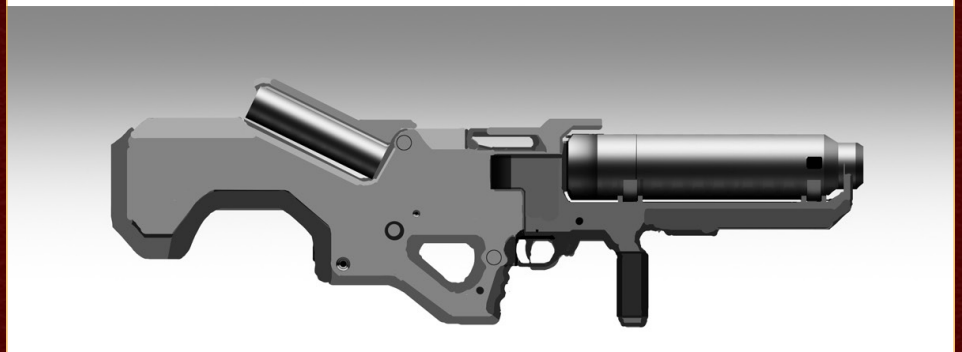
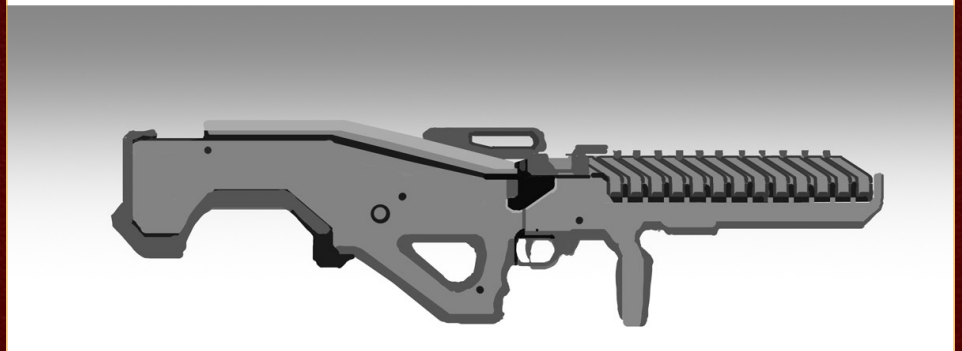
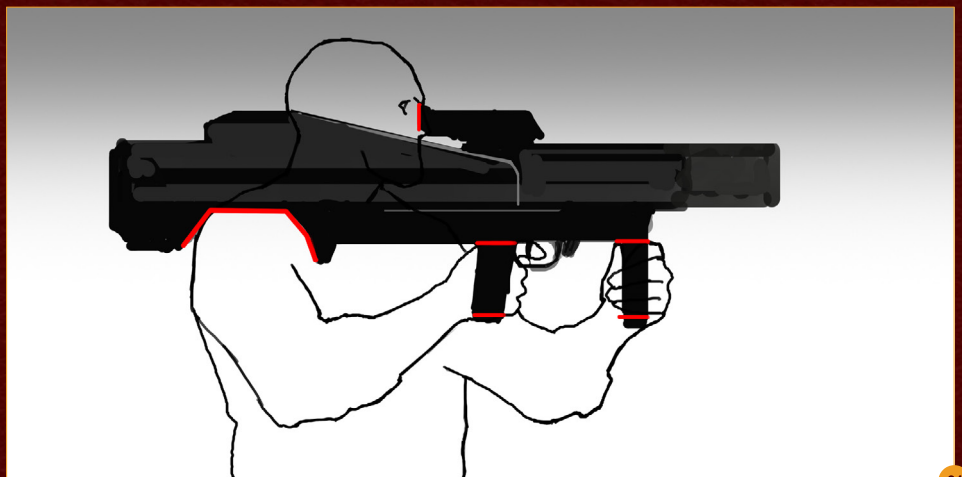

At this point I'm somewhat happy with the direction it's going. I gradually start adding in details. I paint in general areas of highlights and shading by isolating areas with the Polygonal Lasso tool and painting with the Airbrush tool. This gives me nice clean edges. To get a metallic effect, I'll usually use an airbrush with the brush blend mode set to Color Dodge. I also paint in a scope and general bolt details, which I think are just as important to the overall composition of the design (**Fig.03**). Again, it's a balancing act.

Adding an element in one area could suddenly change the design and composition of the entire piece. A general rule that I usually keep in mind is to avoid spreading elements out evenly. This tends to create a flat and boring design. I'm conscious of keeping areas of negative space that compliment the areas of detail.

I establish guides to make sure my lines are consistently parallel (**Fig.04**). If I were to design a gun that was a little more alien then I would probably try a theme with less parallel lines.

I lay down a base color and at this point I'm starting to feel that it is heading in the right direction (**Fig.05**). I decide to stick with two colors: a main dominant color and a neutral

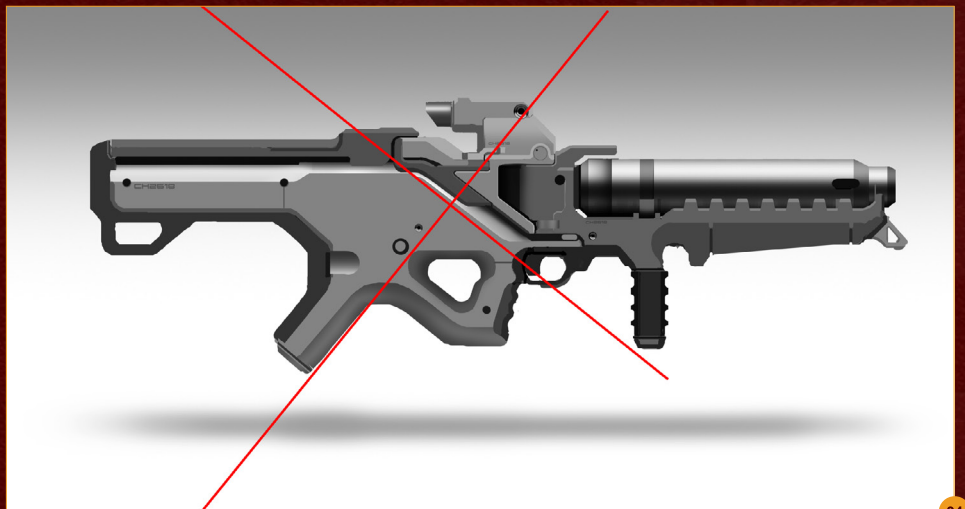
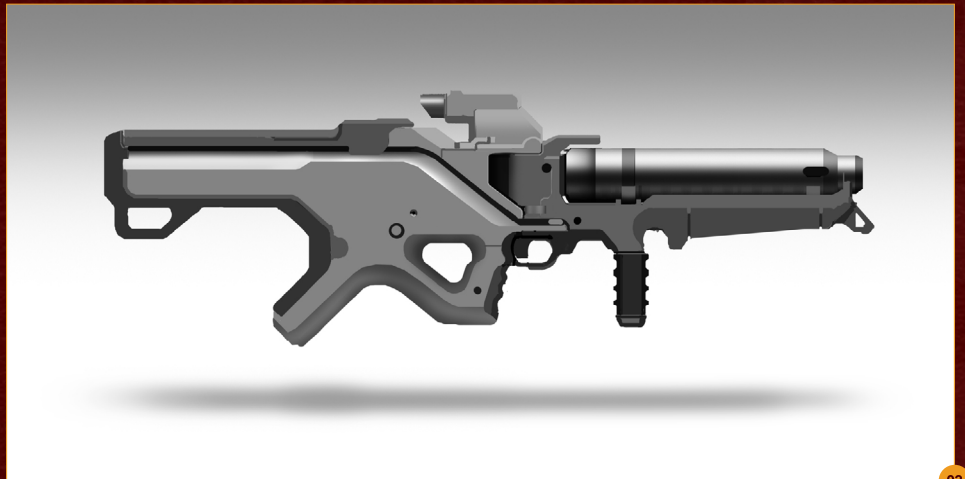

gray. I'm careful not to choose two dominant colors that would compete with each other, so using a neutral tone is a nice compliment to the main color.

I also start laying down some textures to add detail (**Fig.06**). I have a scratch/rust texture and a brushed metal texture for the overall surface, and a leather/plastic texture for the handle





06



07

CH2618  
T2CH94



08

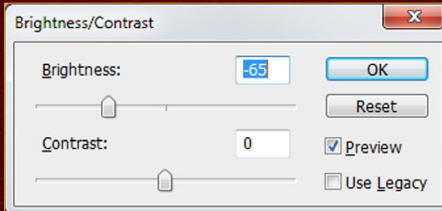

09



10

areas. I play around with the blend modes to see which one fits the best.

Even though the design isn't finished yet, I find putting down base textures helps me to see the end result a lot faster (Fig.07).

I also add more detailed bolts, a graphic logo and random numbered decals in areas where

it feels appropriate (Fig.08). I keep these in separate layers, so that I'm free to adjust the placements where necessary.

I use the Brightness/Contrast adjustment layer with a mask to add shading to the weapon. You can stack multiple layers for added flexibility and control (Fig.09).

It's now a matter of looking at all the areas to see where to put the details. I think it's really the details that sell the "coolness" of the weapon. I paint in a scratch pass to give it that extra level of wear and tear. Adding in a light strip in the back gives it that sci-fi feel (Fig.10).

Now it's just a matter of going through each area and adding in highlights and shading to

make the image pop. The image is pretty much there at this point; I could go on forever with the details when I reach this stage, but the challenge is knowing when to stop!

Brian Sum

Web: <http://briansum.com/>

Email: [brian@briansum.com](mailto:brian@briansum.com)





**Z-12 Thumper**  
rocket launcher

# HOW MUCH DID **YOU** LEARN LAST WEEK?



**PETR BALATKA**

PRIOR TRAINING: **NONE**

TIME IN SCHOOL: TWO MONTHS

TOTAL MODELING TIME: **ONE WEEK**



**DAVE SCHOOL**

DIGITAL ANIMATION & VISUAL EFFECTS

[WWW.DAVESCHOOL.COM](http://WWW.DAVESCHOOL.COM)

**AVAILABLE NOW!**  
DVD, Digital Download, Subscription

# LEVEL UP YOUR DIGITAL SCULPTING SKILLS TRAIN WITH KILLER ARTISTS

## 3D CHARACTER DESIGN SERIES WITH SCOTT PATTON

In this two volume series, Scott Patton shows the processes he uses to create a 3D character for feature films. The first volume explores Patton's fast and efficient method for concept sculpting, skipping the 2D sketch phase all together and designing the character entirely within ZBrush®. He covers everything from blocking out the forms and fleshing out the muscles, to adding props, detailing with alphas and posing the character. The second volume covers methods for creating a final color rendering using ZBrush and Photoshop®. Patton shows how he squeezes the most from ZBrush's powerful renderer to create both a wide and close-up shot of the character. He then shares creative Photoshop tips and tricks to quickly get to a finished piece of concept art from the ZBrush renders, covering topics such as adding and refining skin texture, hair, eyes, shadows and scars. Patton also discusses how to create backgrounds that enhance the character and overall composition.



All Tutorials Are Now Available  
As DVDs, Digital Downloads,  
And Part of The Online Training Subscription  
[www.thegnomonworkshop.com](http://www.thegnomonworkshop.com)

# The Six Realms

Chapter 05 – Swamp/Marshland



One of the appeals of many modern computer games is the ability to explore vast worlds created by talented teams of artists and designers. You can wander around, venturing from one realm to another, absorbing impressive landscapes while tackling challenges and enemies of every description. One of the challenges faced by the concept artists working on a game like this is creating a variety of environments that still look consistent design wise. Within this series of tutorials our artists will be showing us how to design six diverse, fantasy realms from the same world while also describing their own painting process.



## Chapter 05 – Swamp/Marshland

Software Used: Photoshop

### Introduction

As the title suggests, this tutorial will focus on a human habitat set within a swamp. The interesting aspect about this particular project concerns the architecture and the manner in which it is dictated by the environment.

In this case it seemed logical to have the buildings raised above ground or, in this instance, the water level. Swamps occupy waterlogged land and depending on the type, can only be traversed by boat in certain situations. This makes the notion of land-dwelling homes limited and so, after scouring the internet for reference pictures, I decided to situate my version within a shallow lake without any significant land mass or protruding islands.

As a result I was left with the option of structures being supported either on stilts or alternatively built around tree trunks and held in place through a series of felled branches. Part of the brief required a citadel and as this would be too large to build around a single tree, I decided to support it through a series of stilts. For the smaller dwellings I thought it made sense to have these wrap around the larger trees, resembling a traditional tree house. With these decisions in mind I made a start on the image.



01

The first stage of the process involved laying down some broad brush strokes in black and white to get an idea about the composition, and where the main light and dark areas would reside. Some swamps are very densely populated with trees, so visibility can be somewhat restricted, which hinders a sense of depth and perspective. In order to house the citadel in the background, I needed to ensure there was a clear line of sight, but at the same time retain a claustrophobic quality, which I felt was important.

**Fig.01** shows the initial sketch, which alludes to the citadel as a silhouette with most of the shaded areas set in the foreground. I moved



02

shapes around the canvas for a while before arriving at this particular composition, but decided that a light source in the background worked reasonably well and would allow me to use this as a way of creating depth in the scene.

**Fig.02** shows three of the key brushes I used in these early stages and in fact, throughout much of the process. As you can see, two are textured brushes and one is hard-edged for more precise drawing; perfect for trees and branches. When you wish to block in sharp-edged shapes or structures it sometimes pays to use the Lasso tool; a method favored by many artists.

The next phase of the painting involved establishing a color scheme, which utilized a new layer set to Overlay in order to preserve the tonal range.

**Fig.03** shows the result of painting a color wash over the black and white sketch. You can see that I have altered the composition somewhat, but the citadel and central tree remain. At this



03



stage it is worth experimenting with different colors until you find a satisfactory palette. In this case I have focused the warmer tones in the background towards the sunlight.

Once the color scheme is roughly decided I often flatten both the black and white sketch and color layer, and start working in color.

**Fig.04** shows such a stage, building on the previous image and enriching the palette. I wanted to portray an algae-covered lake, but the main hurdle in doing so was to avoid it resembling moss-covered ground. When you observe swamps, you'll notice that the water is often obscured completely and hence can appear misleading. However, there are two ways of overcoming the problem. One is to make sure that the base of trees and anything else has a sharp edge to signify they are standing in water, and the other is to have some water exposed and therefore reflecting the sunlight.

This last device is shown ringed in red, with some water exposed in the extreme foreground by virtue of the dark blue patches flecked with gray. Not every square centimeter of water is covered by algae and this means that at an oblique angle there will be a discernible highlight or reflection across it, albeit a far less obvious one.

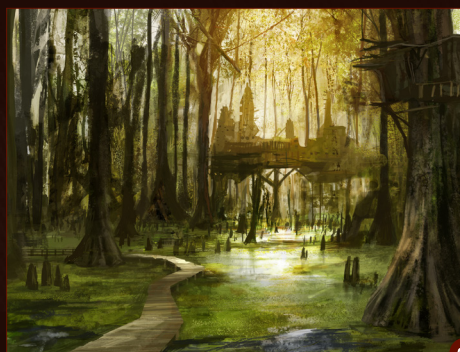

Another aspect I added at this point was evidence of photographs sampled from various sources. Generally I color correct these before reducing the opacity slightly, but often it is possible to simply change the blending mode to Overlay or Soft Light and they will work.

You will have noticed I also started to add some of the tree dwellings, which I went on to elaborate in the foreground of **Fig.05**.

I began to shape the distant citadel by suggesting small windows and protruding supports. To help create a sense of depth and perspective I incorporated a raised gangway above the water level, which also allows the inhabitants to cross the swamp.

I liked the simple treatment of the citadel in its silhouette form against the sunlight, but because it was the focal point I felt it needed a little more detail. The other problem was that it looked

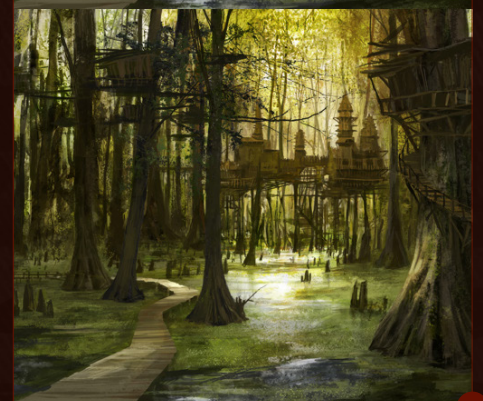

as though it was at the edge of the swamp, whereas I wanted to situate it somewhere in the middle. To compensate I added some fortifications around the citadel and some extra trees in the background (**Fig.06**).

I decided to increase the density of the trees by placing some in the middle distance, but because these obscured the main citadel tower I flipped it horizontally to show the prominent towers.

The haphazard array of branches and foliage in the center of the image lacked any real structure, so I decided to edit these to form two distinct tree houses (**Fig.07**).

A good way of adding color is to use Overlays set to various blending modes. In order to add a more vivid green to the background foliage, as well as a warm tint to the sunlight, I created two new layers. **Fig.08** shows the image with both layers set to Normal mode in the center, and the before and after effects on the left and right respectively. The sunlight (ringed in red) was set to Hard Light and the green patches to Overlay.

Whilst working it is very helpful to flip your canvas both horizontally and vertically; something you will hear many artists mention for a very good reason. This technique can either reveal flaws or alternatively help solve problems. In this case I found there was a lack of continuity



between the upper and lower halves of the canvas mainly due to the color scheme. One way of binding the background and foreground was to tint the reflection across the water to match the sunlight by way of a new layer set to Hard Light (**Fig.09**).

Part of the brief required a beacon fire being visible from the citadel, so it was important to include this. Being a swamp I imagined that a clear line of sight from village to village would be difficult and so it would be necessary to place a lookout above the canopy. In order to spot the fires they would need to create a lot of smoke.

**Fig.10** shows just such a fire in the background, which I have placed on top of a high tower in

order to make the smoke more visible. The placement of this didn't feel balanced in relation to the two tree houses either side, so I opted to move it over to the left (**Fig.11**).

Two final touches that I felt were necessary was to first of all correct the perspective of the gangway, which seemed skewed, and then add some evidence of human occupancy. I placed a fishing boat in the foreground, but due to the lighting and color scheme I had to cover the lower left section with algae in order for the boat to make more sense visually (**Fig.12**).

Richard Tilbury

Web: <http://www.richardtilburyart.com/>

Email: [ibex80@hotmail.com](mailto:ibex80@hotmail.com)





# Add **Vue** to Your Skillset

© 1999-2012 e-on software, inc. All rights reserved. Vue, Carbon Scatter, Ozone and LumenRT are trademarks of e-on software, inc. E-on software and the e-on software logo are trademarks or registered trademarks of e-on software, inc. All other trademarks or registered trademarks are the property of their owners and are used for identification purposes only. Information in this document is subject to change without notice. Items displayed on this document are not necessarily supplied with the package.



Vue image by Evan Guzman

Vue 11 now available: [www.Vue11.com](http://www.Vue11.com)

## 3D ENVIRONMENT COMPETITION 2012

3D ENVIRONMENT - CHARACTER RENDERING - ARCHITECTURAL VISUALIZATION

Over  
**\$30 000**  
worth in prizes!

Submission ends December 16, 2012  
[www.e-onsoftware.com/competition](http://www.e-onsoftware.com/competition)

SPONSORS



Technologies for Digital Nature



Vue



Carbon Scatter



Ozone



LumenRT



Meet modo.  
**Luxology**

# CARTOON CREATION 101



Everybody loves cartoon characters, at one point or another we've all appreciated them. Whether they were in childhood shows or films, cartoons allow us to experience stories that are beyond limits. In this tutorial series our artists will show us how to design and paint basic cartoon characters. This will involve them producing numerous exploratory designs and showing you how to capture and reflect the personality of the character through expressions, costume and design.



## Chapter 03 – Loan Shark

Software Used: Photoshop

Hi guys! Today I'll be showing you how I designed a loan shark. It's quite an exciting character to design, with a lot of cultural references. Loan sharks are widely used in movies and literature, and are definitely one of the most interesting characters I've had a chance to work on.

Before actually starting to design my loan shark, I have to decide what he should look like. What are his main attributes and characteristics? I imagine this guy to be around 50-60 years old, bulky, stocky, maybe fat, maybe bald, or with brown or black hair. He is a respectable man, well, at least in his neighborhood. He is rich and as a sign of his social status he wears a lot of gold; a gold watch and heavy golden rings.

Basically his social status and respectability are the only things he cares about, because they provide a solid basis for his business.

His everyday activities lie within that gray area between criminal and legal business, which allows him to hang out with a bunch of bad guys and at the same time stay out of prison. He is not a mobster (although maybe he's a former one), but he knows what life on the streets is like.

I imagine him wearing an old fashioned blazer or leather jacket. He might even just wear a shirt with suspenders, something from the early 80s or 70s when he was young, a yellow or red colorful silk shirt, with a funny flower or paisley pattern on it, with bright jeans, snake leather red boots or shoes, and a huge sparkling belt buckle with a big dollar sign decorated with rhinestones. He is a kind of a macho man; he is very hairy, with a hairy chest and hairy arms, and a big black mole on his cheek, which makes him unpleasant to look at.

After I have decided how I want my character to look, I search for photo references on the internet. I imagine him as Tony Soprano,

dressed like Nicolas Cage from *Snake Eyes*. *Goodfellas* is another great movie for research for this reason.

Once I have gathered all the reference material I need for my work, I start doodling. I sketch a couple of tests of different shapes, trying to stick to a square shape in order to make my character heavy and fat. I come up with an idea of a little thin mustache when I sketch a test of the face, which would make him look like some comic banana republic dictator, which is always funny (**Fig.01**).

Jokes aside, at this point I start building up the character with a rough sketch first, then another pass and then another, more refined and detailed version. By the time I have reached the third design, I've made his eyebrows bigger and bushier, and changed his nose from a bulbous one to a hawk-like one. I feel these details will make him look more dangerous and less silly. Another detail which I decide that he has to have is a cigar and it has to be Cuban (**Fig.02**).



01

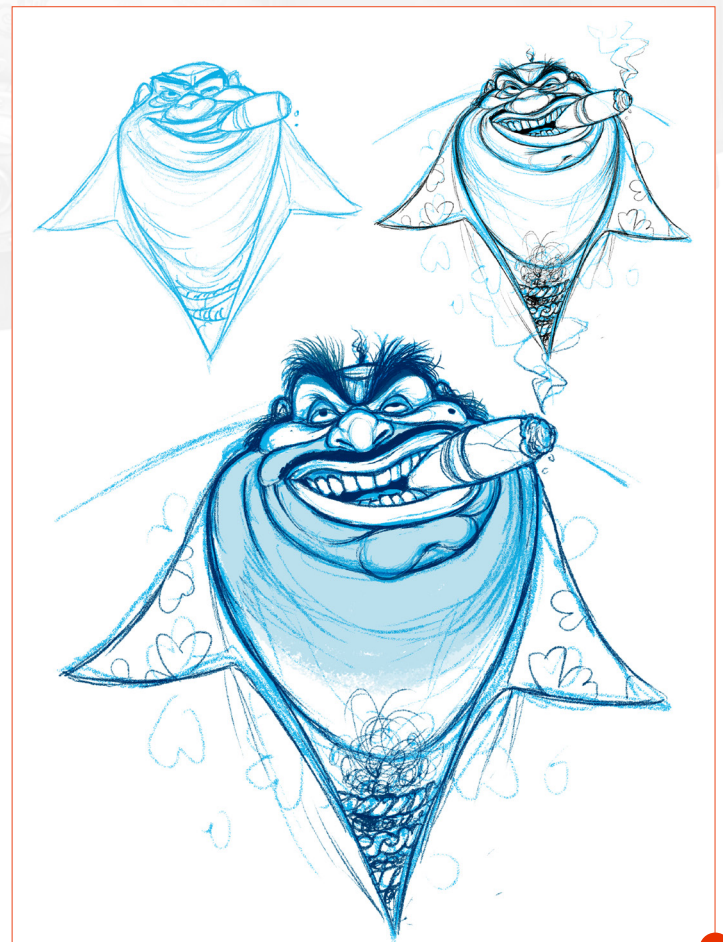

02



03

I move on to another pass, this time from a side view. I complete a couple of full-body sketches from the side, just to see how this character might look in his full scale. At this stage I reach a turning point in my design process. I realize that my design is not good. Well, maybe my loan shark does have a certain amount of character, but he's turned out too realistic, too complicated, less simplified and stylized than I think he should be. I feel like I need a funnier character, someone more suitable for an animated movie, someone more exaggerated and grotesque. I decide to start over (Fig.03).

In Fig.04 you can see the new design that I come up with. As you can see it is a completely new style, with new proportions, less realism and looks more grotesque. I have left the main attributes of his personality, his outfit and his body type, but just changed my overall approach by making him in more of a cartoon style and less of a caricature.

I sketch another pass of the side view. It's important to keep the same proportions when you switch to the side view. In most cases I have to tweak my front view as well, because not everything that looks OK in the front view looks the same when you place it within a 3D space. That's why I think it's really crucial to imagine your character as a 3D object at the very beginning of your design process;

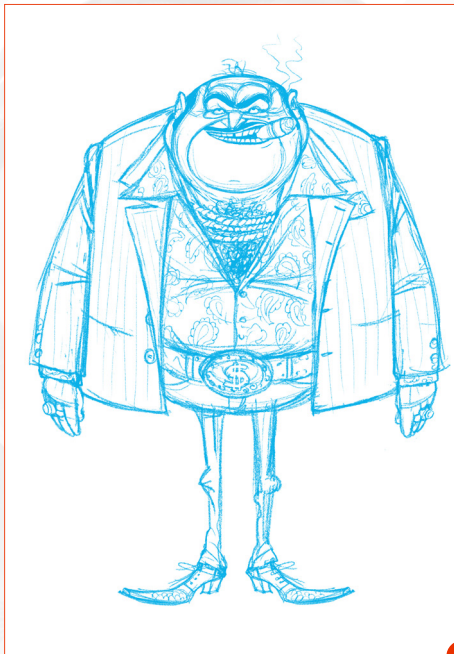

04

otherwise you may end up with something that will be really hard to animate later (Fig.05).

In Fig.06 you can see a few hand poses that I have sketched. I wanted him to have fat fingers and small nails. His palms are very soft because he has never done a hard day's work in his life; the heaviest thing he has ever lifted is a roll of bank notes. He talks a lot with his hands, using very expressive hand gestures, mostly with two or three fingers and usually while holding his beloved Cuban cigar.

I continue to sketch a series of facial expressions. Our guy has a fat and fleshy face,

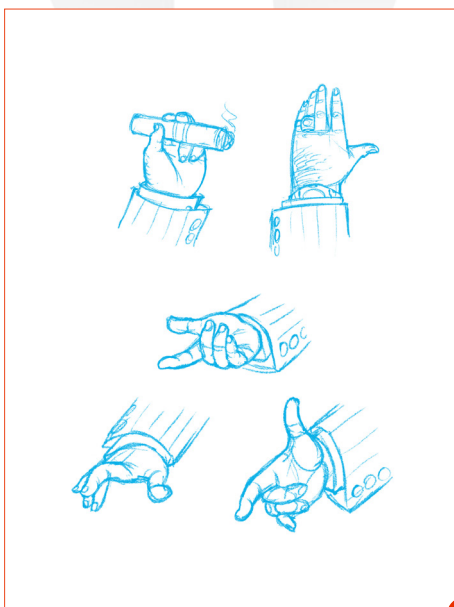

06



05

so when his facial muscles move or when he moves his jaw down or to the side, the whole of his face changes shape. The most important feature of the face for expressing emotions is the eyebrows, so I had to make them as big and flexible as physically possible. In real life, and especially in animation, when eyebrows move so does all the upper parts of the face: the forehead, eyelids and nose. When working on facial expressions, it's a good idea to keep those things in mind (Fig.07).

At this point it's time to start painting our character, so I put my sketch on the top layer, with 10-20% opacity and Multiply blending

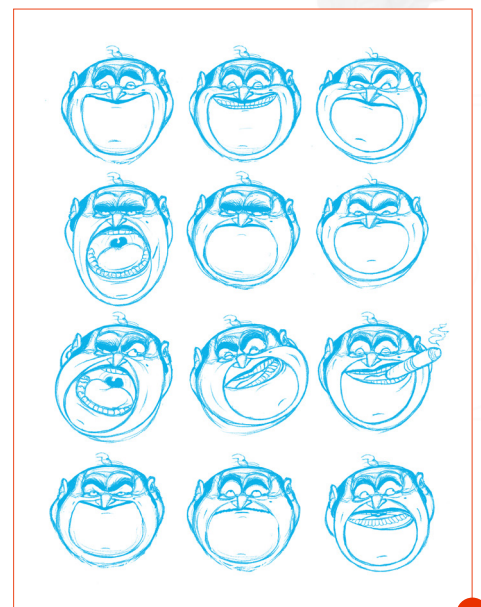

07



08

mode; this is so I can clearly see what is happening beneath. Then I create different shapes with the Photoshop Pen tool, separate them into different layers and lock their transparency. I color these shapes with basic colors, with each color block in a separate layer. This makes my life easier when painting, as by working with an object in a separate layer you can always undo decisions that don't work without ruining the whole image.

Apart from painting, I make one design on the spot, well, two actually. First I decide to give up on the idea of him being bald, and instead give him a nice, greased, black, mobster-style haircut. It makes him look stronger and more masculine; less like an accountant and more like a guy you wouldn't want to mess with. The second decision is to change his bright blazer to a leather jacket, which makes him look a bit less classy and more of a low-level thug. The leather jacket, in my humble opinion, looks much cooler than any blazer. I have one myself and Tony Soprano, by the way, had one too; you don't need any more reasons than that (**Fig.08**)!

I reach the stage where I begin blocking in basic colors and volumes, as sort of under-painting that I will later refine pass by pass. On the subject of basics, I usually tend to start to color an image with an ambient occlusion. This means that firstly I decide what the lighting conditions are within the scene and



09

what is the diffused lighting. The color of that diffused lighting will strongly affect every object (especially the shadows) in my scene, making colors shift toward warm or cold sections of the spectrum.

In this particular case, my character is placed within a neutral white environment, so there is no color shift. But when it comes to adding highlights, reflections and polishing later on, I'll have to add some subtly white reflections on the edges of highly reflective objects, such as hair, metal, leather and human skin.

For now the only thing I do is paint soft shadows on the Ambient Occlusion layer, in areas where diffused light doesn't reach. I also make the surface that we see from bigger angles slightly darker. Although our main lighting is diffused, (e.g., coming from all around), as long as there is some kind of floor in the scene, even a white one, the amount of light coming from above will be significantly bigger than that reflected by the floor. So, basically all surfaces facing downwards will be darker than those facing up (**Fig.09**).

At this point I am almost done. The two most important elements to this character are his face, of course, and his leather jacket, so I paint them first. They both have to be rendered perfectly – the face for obvious reasons and the jacket because if it isn't it may look like



10

plastic. Leather has its own unique texture, which reflects light differently in different areas, dependant on how greasy or shabby these parts are. In many cases manufacturers also add some texture variations to leather, so we should take all these details into consideration when painting leather.

In addition to the white diffused light, I decide to add another light source: some kind of warm, soft spotlight right above our guy's head. This will make the skin tones warmer and will also make the shadows darker. (In physics terms it's not true of course, it's only an illusion created by the higher contrast between shadows and light) (**Fig.10**).

I complete a final pass and a side view of the character is added. I do a lot at this stage. I paint a nice paisley pattern on his shirt, finish his white jeans using a rough fabric texture, and paint his shoes using a real snakeskin texture. I also paint his hands, golden rings and his belt buckle. I tweak the tone of his skin, making him slightly redder; I also add some additional highlights and made the shadows darker in some places (**Fig.11**).

With that he is done. I hope you like him!

**Denis Zilber**

**Web:** <http://www.deniszilber.com/>

**Email:** [deniszilber@gmail.com](mailto:deniszilber@gmail.com)





# Custom Brushes for Characters

## Chapter 03



**DOWNLOAD  
RESOURCES**



- Free Brushes

A custom brush can add that special texture or help speed up your workflow. You can use a combination of custom brushes to quickly add cracks, dirt and scratches to textures or images, or use them to paint an underlying texture such as skin, cloth, leather and metal to a section of a painting. In this tutorial series our artists will show us how to create different custom brushes to texture a character. This will involve them starting with a basic un-textured character that they have designed, and then demonstrating how to create brushes to add areas of texture and detail.

## Chapter 03 – Beaten up Thug

Software Used: Photoshop

In the following tutorial I'm going to show you how to create a thug character, from a rough thumbnail to a finished concept drawing. I will then take that same character and, by using a small handful of brushes, will bruise, cut and scrape him so that he looks like a beaten up version of the original (**Fig.01**).

There are five brushes that I will use primarily for this tutorial. The first brush in the bunch is a simple default Round brush in Photoshop. I have the brush set to Pressure Sensitivity, so that it feels fairly close to rendering with a pencil. Personally, I use this brush most often, but as you'll see, other unique specialty brushes can help in the process of creating a concept much more quickly (**Fig.02**).

The second brush is one that I found online by artist Yang Xueguo, in a free batch of brushes he was kind enough to share with the public. I find that this brush creates abstract shapes that help to paint details and what I call "noise", to add to the realism of any given painting. The remaining three brushes are custom brushes that I created specifically for this tutorial to paint strokes that I will talk about later.



01



02



03

In **Fig.03** you can see that I always start off with a rough thumbnail, whether I'm painting a quick concept of a character, a lush environment or a complex scene that consists of both characters and scenery. I will first do a set of thumbnails to get an idea of what I want in terms of design and composition. Since this tutorial is specifically about brushes, I'm keeping the concept fairly

straight forward and I don't do too many thumbnails. Basically I want a thug that looks like you wouldn't want to mess with him!

### Moving Forward

In **Fig.04** I'm simply taking the basic structure of the face that I roughed out earlier and pushing it in a more refined direction.

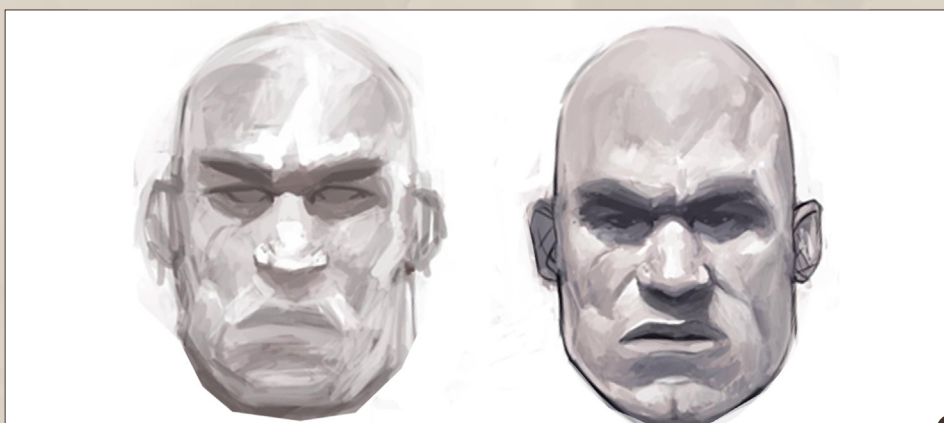

04

I'm starting to paint in the details more for his overall body. In both cases, I've used the first brush of the group mentioned earlier (Fig.05).

### Keep Things Loose

Everything I've done up to this point is still fairly loose and I keep it all pretty monochromatic, without any vibrant colors. Early on I like to keep it somewhat simple value-wise. For me personally it helps to stay focused on what's important at this stage, and that's the design.

For this particular concept I want the character to have a tough face, and look very rugged and mean. I give him deep set eyes and use very angular and jagged shapes to construct his face; there are no rounded or soft edges. I also increase his muscle mass from the early thumbnails. I want this guy to be intimidating and basically somebody that has seen trouble before. Maybe his face has some scar tissue already, as if he's been beaten up before.

### Quick Tip

I always start with very broad brushes early on in any given concept. I usually have an idea of what I want, but by keeping things very loose with a big brush, I can usually find nice accidents in the brush strokes that I later turn into specific areas of the design. Also by using a big brush early, it prevents me from getting too tight and carried away with the little details

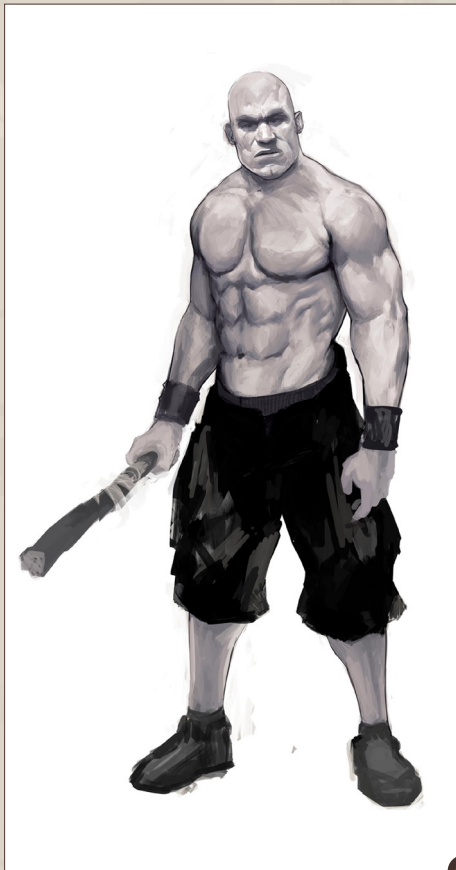

05

that can take away from the overall concept's success and design.

In Fig.06 I've done a basic color copy of my grayscale version. I usually do this by just changing my brush mode to Color and that way I can create a very fast wash over my concept. Then when I'm happy with the fundamental color

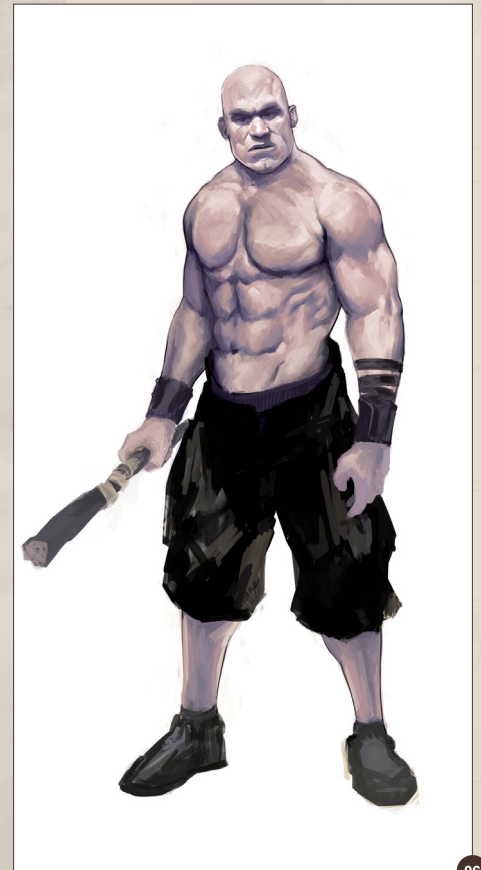

06

scheme I paint over it with my Normal brush again to make sure it doesn't look too digital.

I start to commit to a design at this point. I've decided to change his face slightly, since the previous version was just not quite what I had in mind. At this point it becomes really subjective and if you're working with a client or studio art director, the iteration process on a character's face can go back and forth dozens of times, if not more. Luckily for this tutorial, I'm my own boss and I've decided on this face! I also felt that the shorts were making him feel a bit sporty or just again, not quite what I had in mind, so I went ahead and gave him trousers (Fig.07).

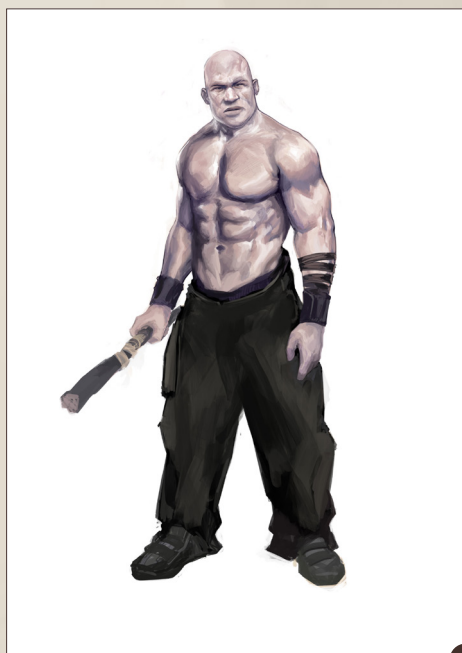

07

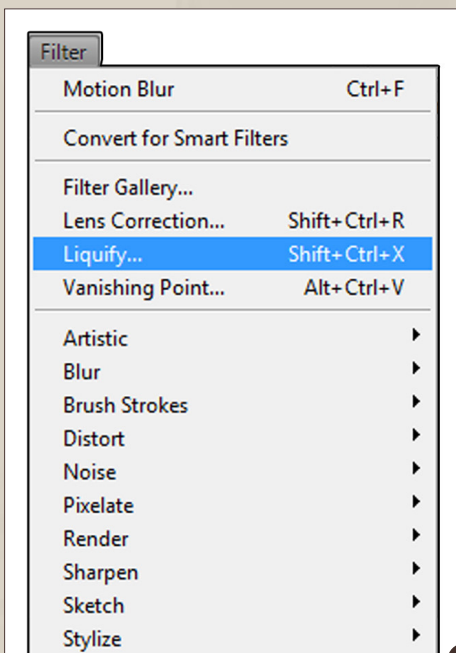

08

### Using Filters

As shown in Fig.08 I use the Liquify filter to push the paint around and create the beaten up look I'm going for. I even use the Bloat tool in that filter to puff out his lips and the areas around his eyes.

You can also see that I've started to use the various brushes that I've created to give the character blemishes and bruises. It's pretty



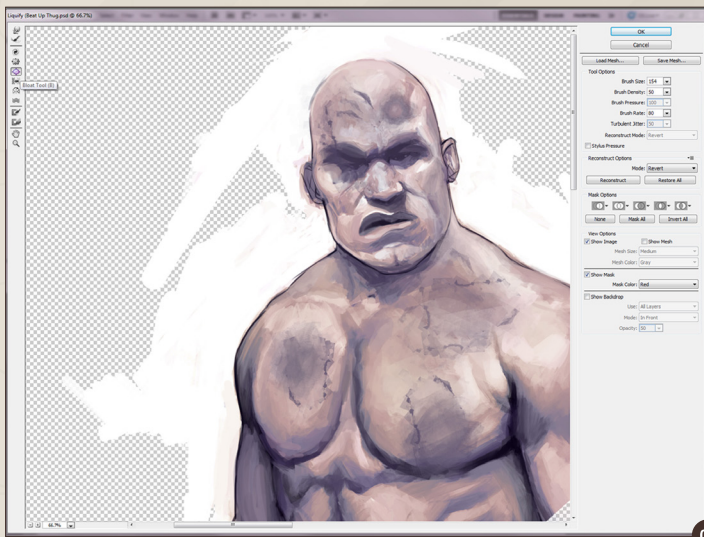

09

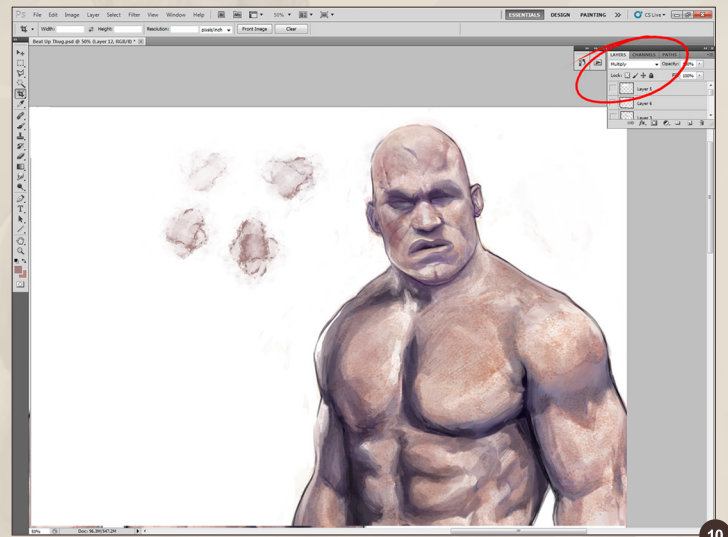

10

random at the moment, but again these brushes create shapes and abstract strokes that I can turn into the exact look I'm going for (Fig.09).

### Unique Brushes

Brushes 4 and 5 from the set mentioned earlier are used to create strokes that I wouldn't normally get from the default Round brush.

### Quick Tip

I always get reference material for areas I'm not already familiar with. With the abundance of references online, there's no excuse not to grab reference photos for things that you aren't exactly sure how they should look. In this case I wanted to look at bruises and wounds for

reference and it helped considerably, even though I thought that I had a pretty good handle on how they would look. But be careful how much you actually copy versus simply getting ideas and inspiration. Your copied reference material can end up becoming very stiff and you want to learn as much from your references as possible and not just become a Xerox machine.

### Blending Modes and Brush Properties

In Fig.10 I'm still using the same brushes, but I'm experimenting with different blending modes on the layers where I apply the brush strokes. By using different modes, you can get varying effects. In this case, the Multiply layer gives me

some depth and an overall saturation level that feels stronger and more successful to me.

Now I've created some additional textures for his flesh by adjusting some of the brush properties (Fig.11). By playing around with these sliders (Fig. you can add a tremendous amount of variation to your brush strokes and the effects that they can give you. I use the basic round brush and make some changes to its properties. By putting the new strokes on a Multiply layer I'm able to get the feel I'm looking for.

I also use the Warp tool to stretch out some of the strokes, until they conform nicely to the flesh and muscles, as you can see in Fig.12.

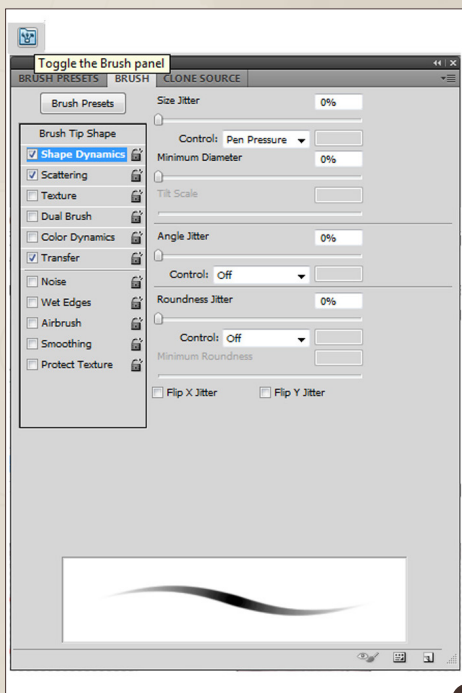

11

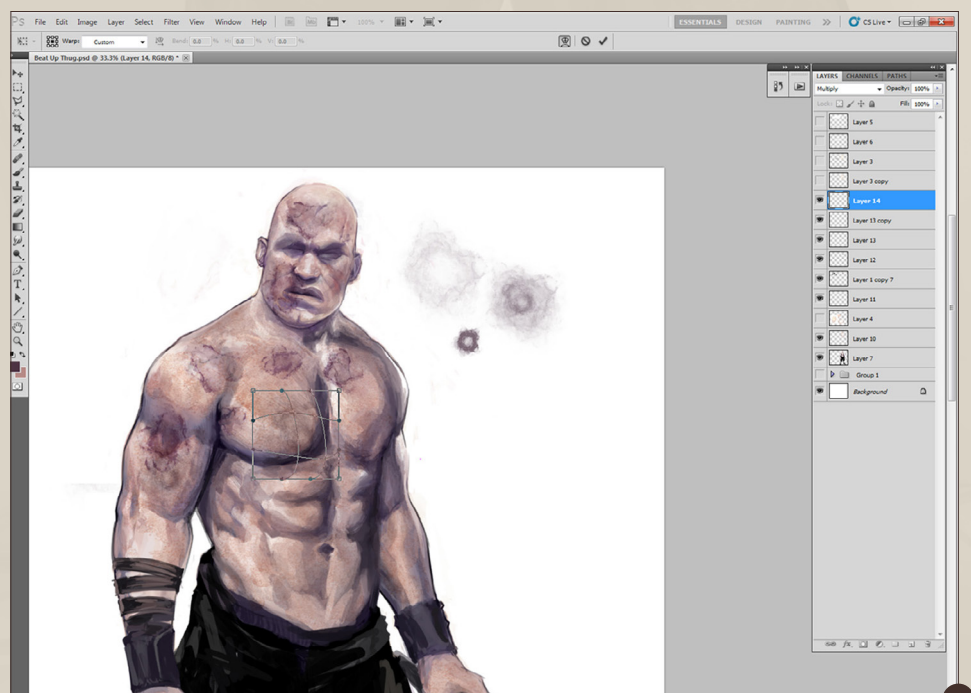

12



13

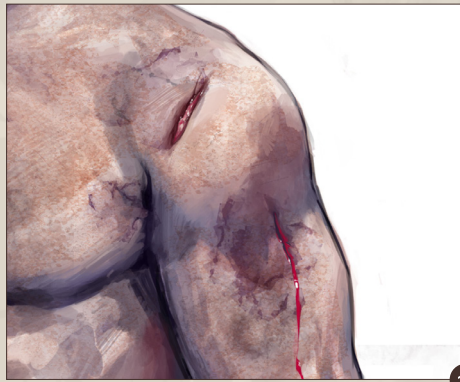

14

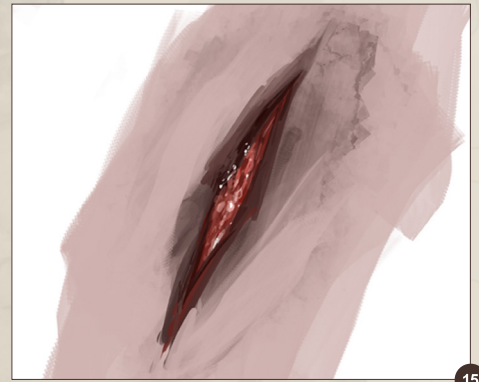

15

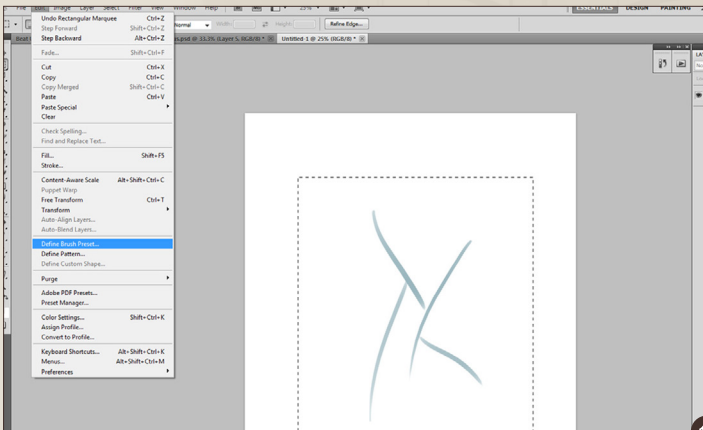

16

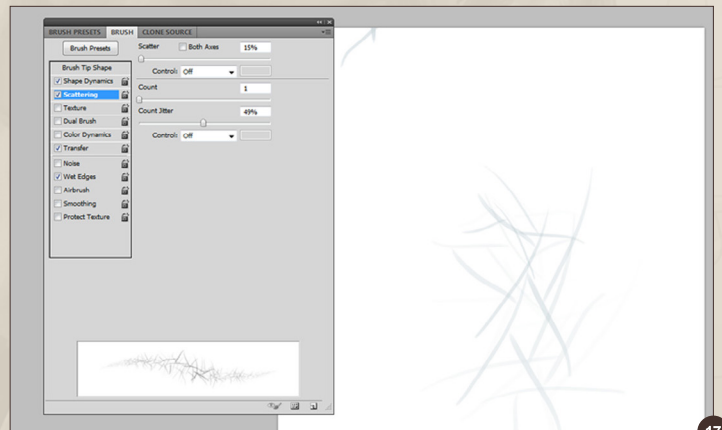

17

### Back to the Basics

In Fig.13 – 14 I am showing how I used the basic round brush to do the majority of the work to finish of my concept. While I definitely do use custom brushes, textures, filters and adjustment layers, at the end of the day my basic round brush is used most often to paint the majority of the concept. This is mainly because I find I have the most control with the basic round brush. There are no surprises with what I'm going to get with that brush. I treat it the most like a pencil out of all my brushes and I am able to render as needed with the brush over the top of the strokes that the unique brushes have created.

In Fig.15 you can see a close up of what I'm talking about. My custom brushes help to create some of the noise that makes up the flesh and bruising, but I go in tight with my basic brush to create the actual gash.

### Quick Tip

It's great to have specific brushes that you need for textures that are common like dirt, wood, grass, flesh, etc. Also a good noise brush is great and can come in handy for both characters

and environments. Brushes can help to create mood and atmosphere, but be cautious in how you use them.

Don't rely too much on custom brushes; remember, without the knowledge of some basic art fundamentals, a painting will suffer by simply using various brushes and not applying that knowledge of anatomy, composition, color and light, etc. An artist should be able to create the ideal material he's looking to paint with the simple default brush and some modifications to pen pressure, or opacity.

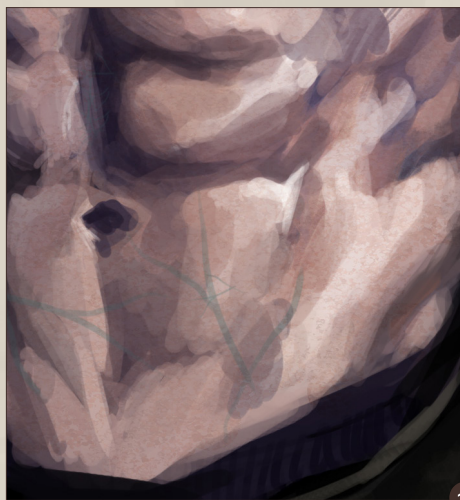

18

### Creating a Brush

In Fig.16 – 17 I demonstrate how to actually create a custom brush. Here I want a brush to add some subtle realism to the flesh, like veins. By putting down some simple brush strokes then selecting Define Brush Preset, I've now created a brush at its simplest level. Now I can go in the brush preset menu and, as mentioned earlier, by experimenting with the sliders I can get varying effects.

### Subtlety is the Key

Fig.18 shows the use of the new vein brush that I created, but it's hardly noticeable unless



19

zoomed in close. It's important to make sure that everything isn't too in your face. Sometimes less is more.

## The Final Progression

Fig.19 – 20 show how the concept moved from its original design to the now beaten up and torn apart thug. Throughout the process the various brushes were used to create textures for skin, blood, cloth, stone, and I even created a quick custom brush to rough in a tattoo. The final concept is not a finished illustration, but it's a design that can be handed off to a modeler or can be easily assessed by a client or art director to determine what, if anything, needs to be addressed or added.

## Bart Tiongson

Web: <http://riceandeggs.blogspot.com/>

Email: [btiongson@robotentertainment.com](mailto:btiongson@robotentertainment.com)



"I didn't use photo-based textures, because I wanted to take a more painterly approach to this picture."



— THE —  
**HELL SALOON**

Professional concept artist and illustrator, Andrei Pervukhin, talks us through how he created his stunning image 'The Hell Saloon'. From concept to the coloring process, Andrei covers it all in this month's Making Of.

## The Hell Saloon

Software Used: Photoshop

### Introduction

I have always been fond of cowboys and westerns, so I wanted to create something in this style. I decided to add a twist to the usual western plot, and add a mythical element. I had the idea to introduce a creature to the scene, which was invoked by an Indian's curse.

### Sketch

As usual, I began the sketch in black and white mode. In the first stages of the sketch the composition looked like **Fig.01**. I later decided to play around with the size of the canvas using the Crop tool in Photoshop. As a result of my experimenting I made a final decision to change the orientation and size of my canvas.

Due to the change in the size of my canvas, I had to make the composition more complex and add several figures and objects. I then continued to correct my composition by using 'The Golden Rule' (**Fig.02**).

Next, I began the coloring process. I created an Overlay layer, which I filled with one color using the Paint Bucket tool. That's how I created the basic tone for the whole composition (**Fig.03**).

Then I used several Overlay layers in front of the first layer. In these layers I added extra colors to the image and started to color the characters (**Fig.04**).

The next step for creating a more complex and interesting composition was to add some more detail to the characters and draw a quick sketch of the monster sitting on the bar. I added soft and dim light in order to create more depth in the background. For a better perception of composition and characters, I also added a signboard to the saloon. As you can see the structure became more rhythmical (**Fig.05**).

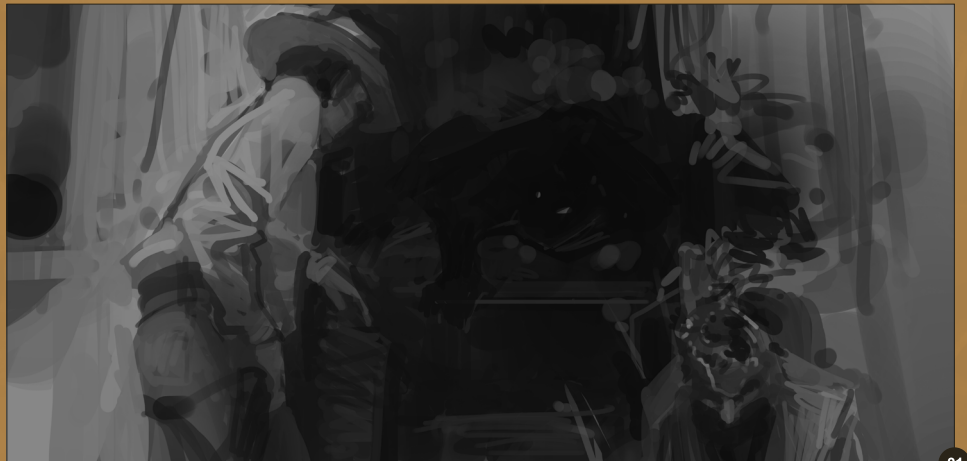



05

Then, to feel the atmosphere of the Wild West better, I made the lighting brighter to create an effect of the sun shining. To achieve this I used a few Overlay and Color Dodge layers. From this moment I began to make the composition and characters more complex by adding more details, such as dust in the saloon (Fig.06).

I completed all of these manipulations on the different layers, so they wouldn't interfere with further changes I might have wanted to make later to the image. Also I began to detail the character who was lying in the foreground. At this point I'd already chosen the final lighting and color design of the picture.

The next step was to reduce the characters's sizes slightly, because they were too big for the size of the canvas and composition that I wanted. Then I continued to detail the picture; for example, I made walls, steps and styled the main character (Fig.07).

The brushes I used for the details in the Normal layer can be seen in Fig.08.

I used the first brush for making the soft light and background. The last brush was mostly used for detailing the ground and the rest of the brushes were basic tools for creating this picture; I combined them to make a picturesque arrangement.



06

Finally I detailed the monster, characters and their clothes, by adding some guns and little finer points of decoration (Fig.09).

I didn't use photo-based textures, because I wanted to take a more painterly approach to



07

this picture. In order to add depth and an air of mystery I blurred the background by using the Gaussian Blur filter. I used a Sharp filter and added a Noise filter to emphasise the expression and clarity.

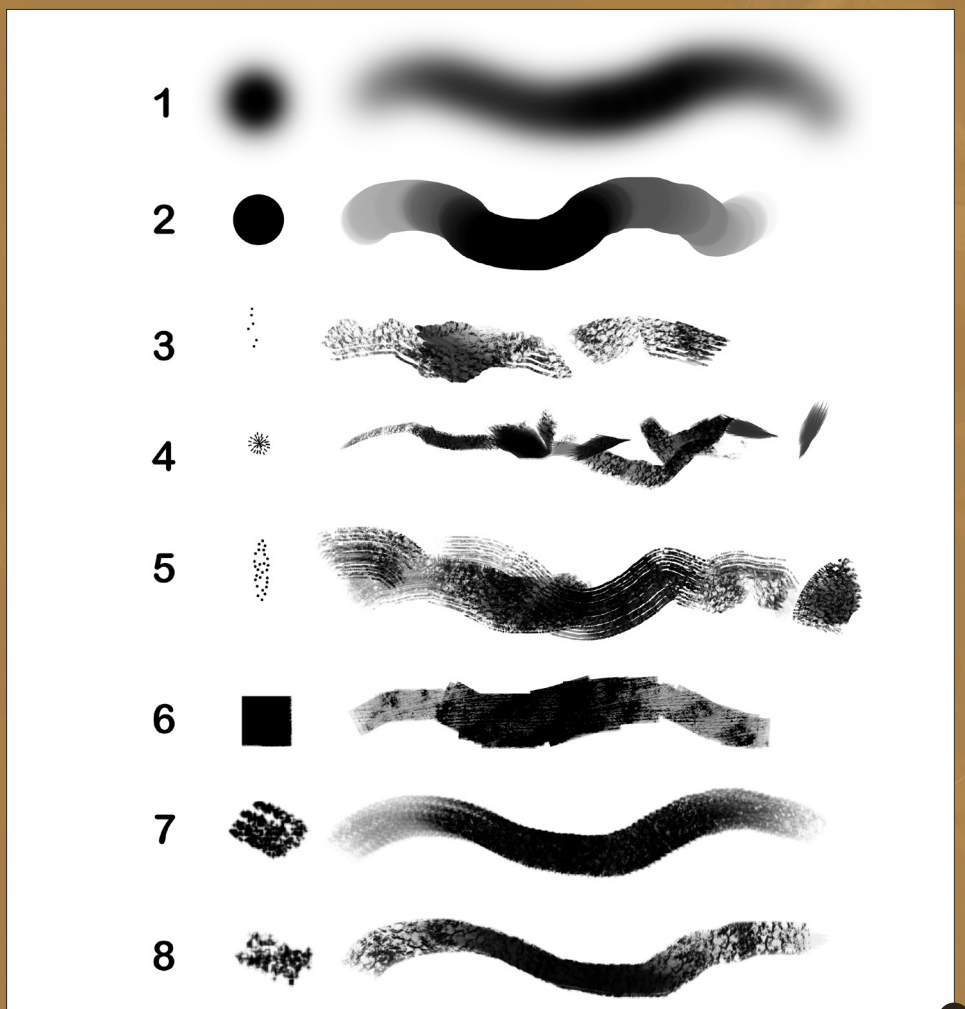

08

Thank you for your attention. I hope you like it.

Andrei Pervukhin

Web: <http://firstear.cghub.com/images/>

Email: [earfirst@gmail.com](mailto:earfirst@gmail.com)





# Subscribe

**NEW PAYPAL SUBSCRIPTION OFFER**  
**SUBSCRIBE NOW & SAVE UP TO 33%**  
on this already amazing value publication!

**12 ISSUES FOR THE PRICE OF 8**  
£23.99 save £12.00 (approx - \$38.99 save \$18.99)

for full information visit:  
[www.2dartistmag.com](http://www.2dartistmag.com)



# 2DA next month

Here is what's in the next issue of 2DArtist

## Interviews

Adam Burn

## Articles

Sketchbook of Eric Velhagen

## Tutorials

### Weapon Design

Chapter 4: Throwing Blades  
by Vadim Sverdlov

### The Six Realms

Chapter 6: Jungle  
by Ioan Dumitrescu

### Cartoon Creation 101

Chapter 4: Opera Singer  
by Johannes Helgeson

### Custom Brushes for Characters

Chapter 4: Alien  
by Richard Tilbury

## Making of

Mr. Wolf by Gediminas Pranckevicius

## Galleries

another 10 of the best  
images from around  
the world!

visit [www.2dartistmag.com](http://www.2dartistmag.com) for  
full information and to purchase  
current and previous issues  
for only £2.99 each!

Image By Gediminas Pranckevicius



**20%**  
DISCOUNT CODE

DIGITAL ART MASTERS: V7

GRAB YOUR EXCLUSIVE 20%  
DISCOUNT CODE AT THE END OF  
THIS TUTORIAL!



3DTOTAL PUBLISHING  
Sample Chapter

EXCLUSIVE MAKING OF  
**RED STEAM**  
BY IGNACIO BAZAN LAZCANO

## Red Steam

Software Used: Photoshop

### Introduction

For over two years I've been working in my free time on a graphic novel. It takes a lot of time and dedication, and sadly I see results slower than I would like to because I only have a few hours a week to do it.

I've always loved drawing historic scenes, characters of the past, ancient weapons and, most of all, rewriting and designing history. My father is a recognized historical researcher and he has managed to convey his love for history to me, which I think has had an impact on my drawings. Of course, he never talked to me about robots or steam war engines; they just came out of my crazy mind and artistic imagination!

I've been amassing ideas for a long time now in the form of drafts and unfinished drawings, most of which are vehicle designs, uniforms and cities. I use these images as an aesthetic guide that helps me make decisions when starting a new drawing.

While I was enjoying one of my few days off I decided to create a new character for my personal collection and specifically for my book. As is often the case, I didn't know in advance



03



01

what I was going to draw. It is not easy to start from scratch, and often when ideas don't seem to be flowing I turn to pictures and films.

Ideas can come from anywhere and anything can act as a source of inspiration. I am a good observer and I do it all the time, generally getting inspiration from colors. My ideas usually emerge from something abstract, such as the way light appears in a certain situation. I often think that a beautiful illustration can emerge from colorful shapes. When working on the image and searching for inspiration, I came across a couple of photographs containing orange flares that pointed me in the direction I was aiming for.

### Creating a Base

I started with a color palette and built the foundation of what would become my picture. Just having the color base was enough to prompt me to start thinking about what would be in the scene (**Fig.01**). My idea was to create some sort of cover for a movie or book, something that really struck a chord with everyone who looked at it. I knew that my drawing would have a central character and something in the background.

When I started to assemble the foundation of the painting, I used a photograph that I liked and moved the colors around. I didn't use any

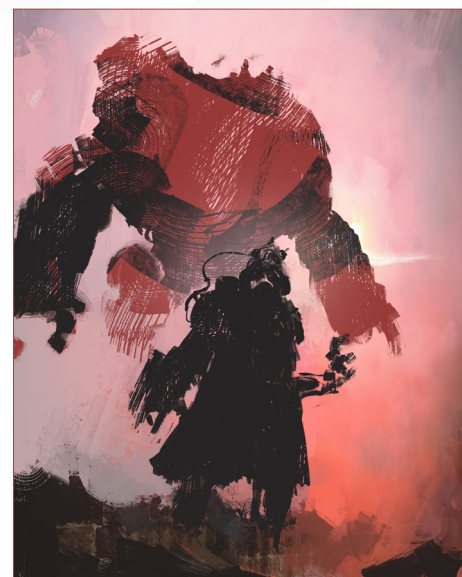

02

filtering or image distortion, but just created a new canvas and painted it with a mixture of the colors I intended to use.

### Composition and Line

The next step was to plan the elements I was going to paint over this color base. Would it be a character in an action pose, a portrait, a landscape? In order to encourage ideas and develop the content I started painting abstract forms until I found something that worked.

For many people this way of working seems very strange and unnatural, but for me to start a painting this way allows me to explore more opportunities.

The next step was to begin defining these forms and the first thing I thought about was a soldier with his war robot. Obviously this phase is not purely random and each stage of development helps me get closer to the idea I'm searching for until I get a definite form. At this point I only had two layers; the first being the background colors, the second containing the figures (**Fig.02**). I then added a new layer and started to add some color and line work to help develop the scene (**Fig.03**).

### Color

To many people this stage proves very difficult, but luckily for me it is the part of the process

that I enjoy the most. At this point I decided to create the color palette, which requires you to start considering the harmony and balance of the image early in the process. Badly selected colors can change the painting's composition and make it awkward to look at, but obviously it is up to your own personal tastes as to which colors you choose (Fig.04). The options are almost unlimited, but for the sake of simplicity I worked with a limited color palette made up of blue, red, orange and green (Fig.05 – 07).

Sometimes you will look at a painting and realize that an artist has used grays and greens on an item that is clearly red. It can make you scratch your head and think, how did he make those colors work? If you can add these extra colors to your palette, your colors will become richer. The key is to find the colors that compliment your base color. If done carefully, this mixture of color can even help to convey an object's material (Fig.08).

Some artists who are comic fans can be afraid of painting over their line drawings as they don't want to lose the overall shapes. In most cases

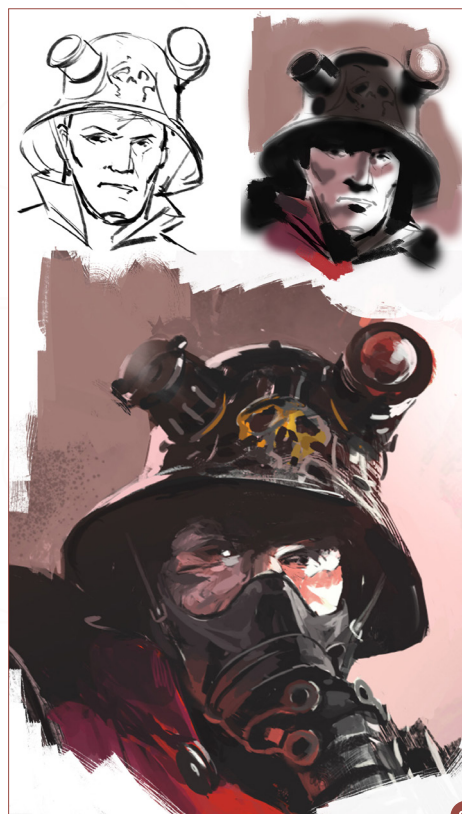

these lines can be painted over with either light or shade, which also helps achieve a sense of realism (Fig.09).

Each element of the painting (whether it be the trees, people or buildings) should integrate colors from the environment. I usually add the

background color into the base that I painted at the beginning. If the robot is red and the background is gray/violet, I will use gray in the red regions to make it look like the character is actually standing in that environment. In general I add the background color to faces that look like they are facing the background. This also

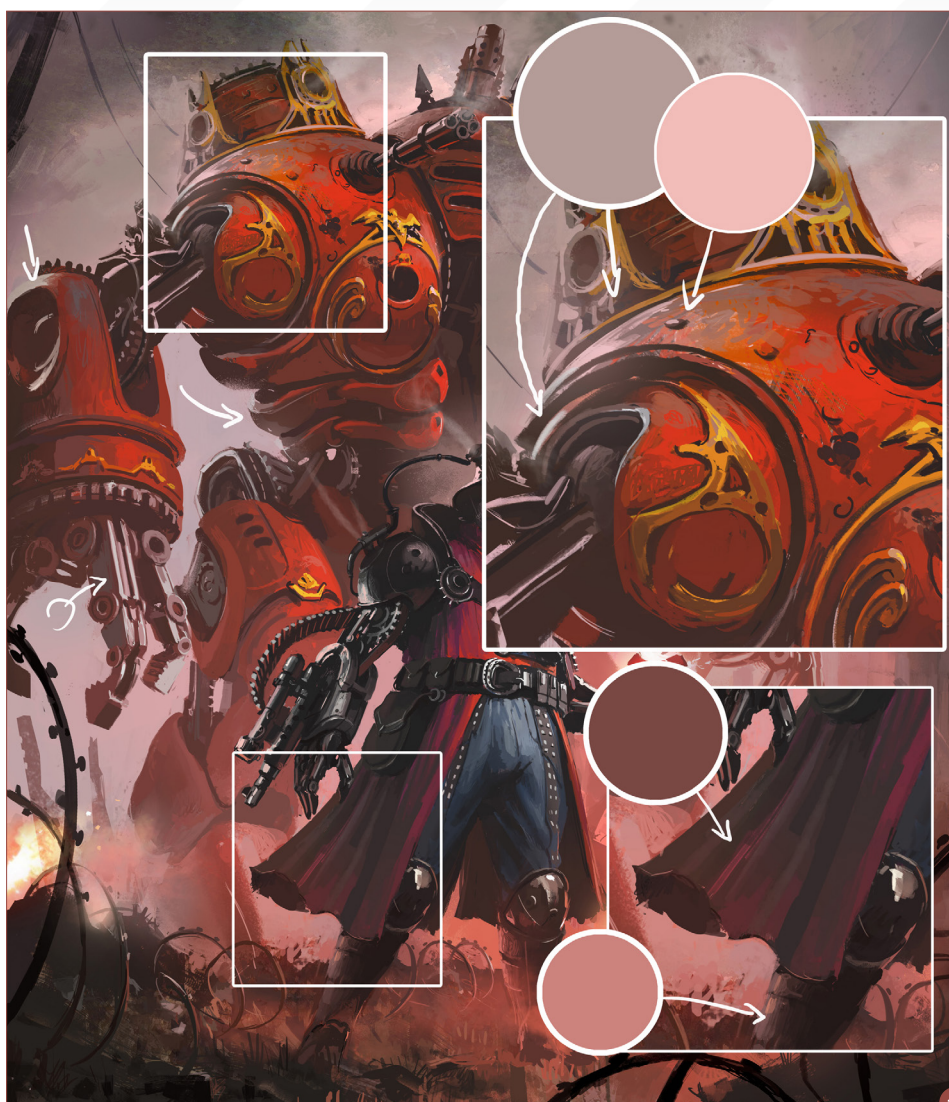

helps to demonstrate depth and distance in the image. Quite often you will see a nicely painted background and character that look like they are not part of the same scene or environment. The key is to mix the colors like this to make everything look as if it is part of the same image (Fig.10).

### Depth

To create depth I painted in a fence and repeated it throughout the image from the foreground to the background. Obviously

I ensured that the size of the fence varied according to the perspective. Whenever you duplicate an object several times in different sizes, you tell the observer that there is distance between them. Repeating elements of the same design provides rhythm and is also useful within the composition, helping to make it look less flat (Fig.11).

Contrast is another way of creating distance, with lighter colors receding behind darker tones. I always use black and whites very carefully and

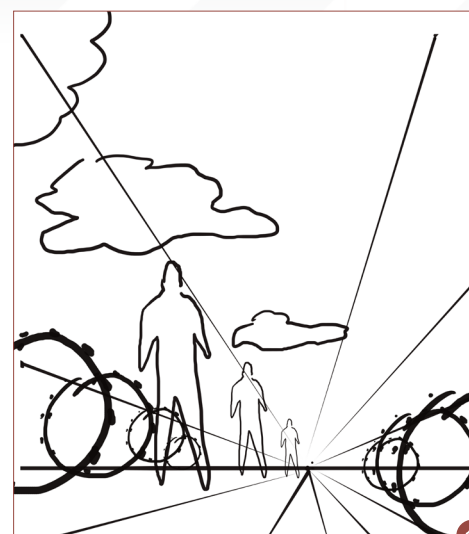

you'll not find a pure black or white color in any of my paintings (Fig.12).

To separate the robot from the character I used a fog effect, which created some distance between them. An easy way of doing this is to use a mask and then paint white into the selected area. You can then set that layer to Screen or Lighten mode and adjust the opacity (Fig.13).

### Final Detail

Once we have the final color palette, and the shape and design of the characters, we can turn to the final detailing stage. To detail this picture I took into account the order of importance so as to draw the viewer's attention to the character more than the robot. The character's chest, side and face are the most detailed areas, followed

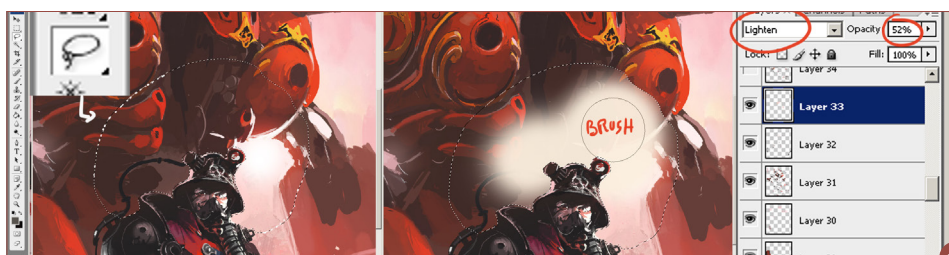



14

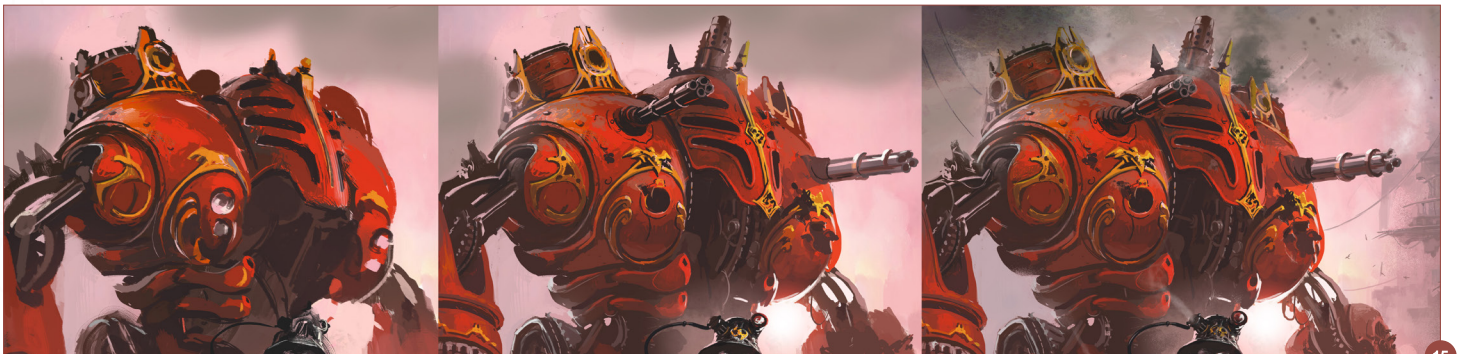

15

by robot's left side, other parts of the chest and arm (Fig.14 – 15).

Special effects (particles, ash, smoke or sparks) will affect color, reflection and shadows. The way that I deal with this is to first define all shapes and add these effects at the end.

One final tip that I would like to offer is in regards to having your image printed. I mentioned at the beginning that I created this as a book cover or poster-like illustration, so I had to consider that it may be printed. When an image is converted from RGB to CMYK, blacks and whites often end up burned and distorted, which can ruin an image. In the case of my image I lightened it to make sure this wasn't going to be as much of a problem when the image is printed. A good way to test this is to simply print out your picture on a printer to see how it comes out (Fig.16).

### Conclusion

It is good to have your own personal project with which you can free yourself from your daily work. I spend all day working for others, fulfilling other's dreams and while I do enjoy doing it, there is nothing more rewarding than having a

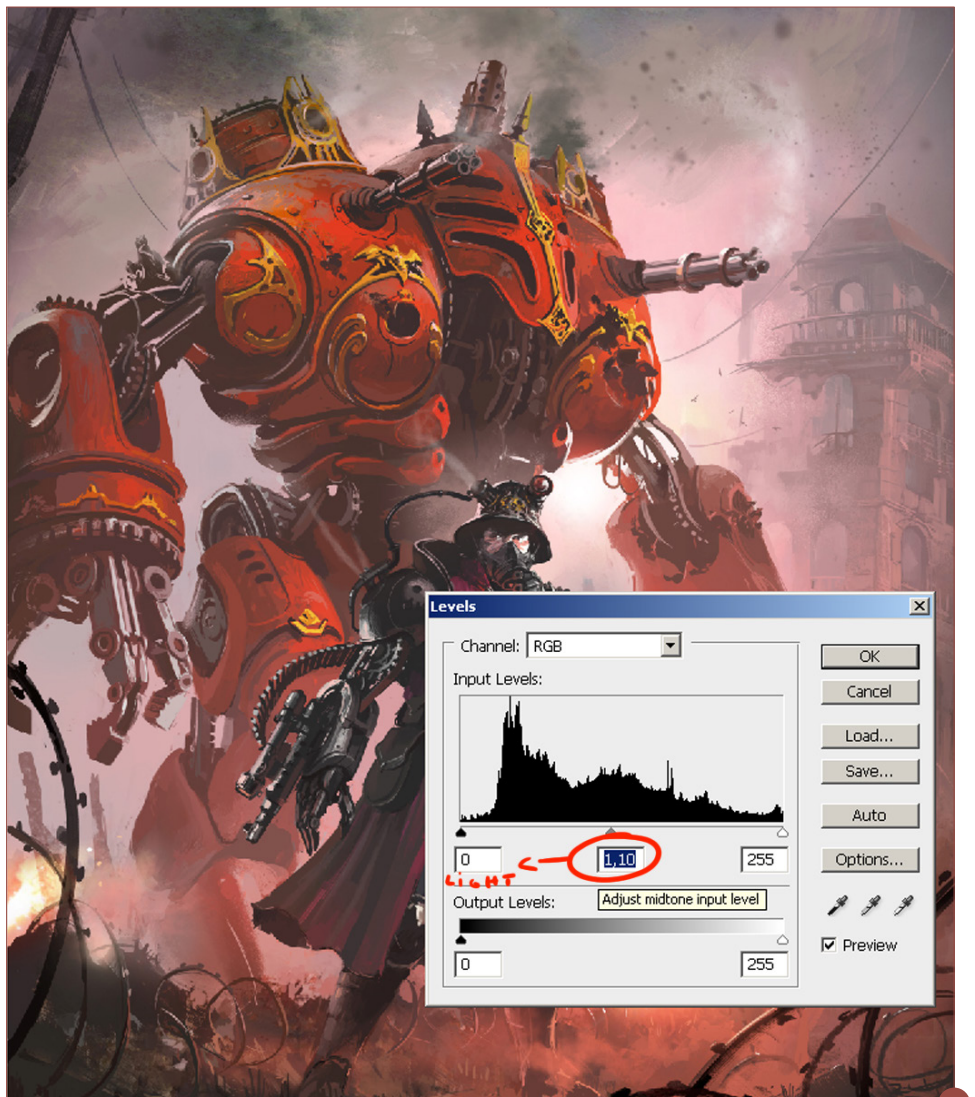

16



small amount of time to work on your own art,  
and to take advantage of your own ideas. I want  
to thank 3DTotal for giving me the opportunity  
to show my work and for providing an outlet for  
artists to share their work with the community. I  
hope you like it!

**Ignacio Bazan Lazcano**

Web: <http://www.neisbeis.deviantart.com>

Email: [i.bazanlazcano@gmail.com](mailto:i.bazanlazcano@gmail.com)



# DIGITAL ART MASTERS

: VOLUME 7

**20% OFF**  
WHEN YOU ENTER  
DISCOUNT CODE:  
**Damv720**

HARDCOVER EDITION ONLY AVAILABLE FROM [WWW.3DTOTAL.COM/SHOP](http://WWW.3DTOTAL.COM/SHOP)

Now in its seventh year, the Digital Art Masters series presents another scintillating collection of work from 50 world-class digital artists.

Over the last seven years, the Digital Art Masters series has brought together over 300 fantastic examples of the world's best 2D and 3D digital art. Digital Art Masters: Volume 7 continues this tradition by ushering in a new elite group of talented artists whose images are sure to inspire and astound in equal measure. This book doesn't just showcase beautiful art; it also offers up details of the creation process behind each image, penned by the artists themselves, presenting a unique opportunity for readers to follow in the footsteps of the masters. Covering topics ranging from fantasy and characters to scenes and cartoons, Digital Art Masters: Volume 7 has something for everyone and is sure to get those creative juices flowing.

Hardback - 21.6cm x 27.9cm | 288 Full Colour Premium Paper Pages | ISBN: 978-0-956881711-2



Visit [www.3dtotal.com/shop](http://www.3dtotal.com/shop) to see our full range of products

**3dtotal.com**



3DTotal presents the new issue of **3dcreative** magazine: a downloadable monthly magazine for digital artists for only **£2.75** (approx \$3.78 - €2.93)



3dtotal.com

# 3dcreative

Issue 087 November 2012

**Ken Toney**  
3D Character Artist

**Yitio Iltanacha**  
Project Overview  
by Daniil Alikov

**Gallery**  
Gallery - 10 of the best  
images from around  
the world!

Cover image by Andrew Hickinbottom

**NEW!**  
ANDREW HICKINBOTTOM'S  
**WORKSHOP**  
**FEMALE PIN-UP**

The Master of pin-up characters **Andrew Hickinbottom** kicks off his new three part 3ds Max Female Character Creation series.

**ZBrush Tribal Creature**  
**Borislav Kechashki** brings to life his fantastic tribal creature in the second part of our ZBrush Quadrapeds tutorial series.

**Beginner's Guide to Modeling Futuristic Vehicles**  
**Arturo Garcia** (3dsmax) and **Renato Gonzalez Aguilante** (Maya) continue the modeling process in the next chapter of our vehicle based series.

**The Submarine Pen - Building Objects**  
**Andrew Finch** brings us the fifth instalment of his Unreal Games Engine Environment series, this month focusing on building and placing objects.

visit [www.3dcreativemag.com](http://www.3dcreativemag.com)  
to see a full preview of the latest issue, subscription offers and  
to purchase back issues.





## 3dtotal.com

Is a resource website for the CG community; amongst our growing number of products for CG artists, we produce two monthly downloadable PDF magazines – 2DArtist and 3DCreative. We are based in the West Midlands, in the UK, and our intention with our magazines is to make each issue as full of great articles, images, interviews and tutorials as possible. If you would like more information on 3DTotal or our magazines, or if you have a question for one our team, please use the links below.

### Contact Information

<http://www.3dtotal.com>

<http://www.3dcreativemag.com>

<http://www.2dartistmag.com>

Editor & Content Manager > Simon Morse  
simon@3dtotal.com

Lead Designer > Chris Perrins  
chrisp@3dtotal.com

Marketing > Emma Handley  
emma@3dtotal.com

### Partners

If you have a CG community website and would like to support 3DCreative and/or 2DArtist magazine by showing our banners, please contact Simon at the email address above

