

Design your own Christmas cards



Desktop printers and a \$1 photo library have made it easy to send beautiful, *personal* greetings!

Continued ▶



Design your own Christmas cards

Desktop printers and a \$1 photo library have made it easy to send beautiful, *personal* greetings! Here are a handful of ideas to get you started.

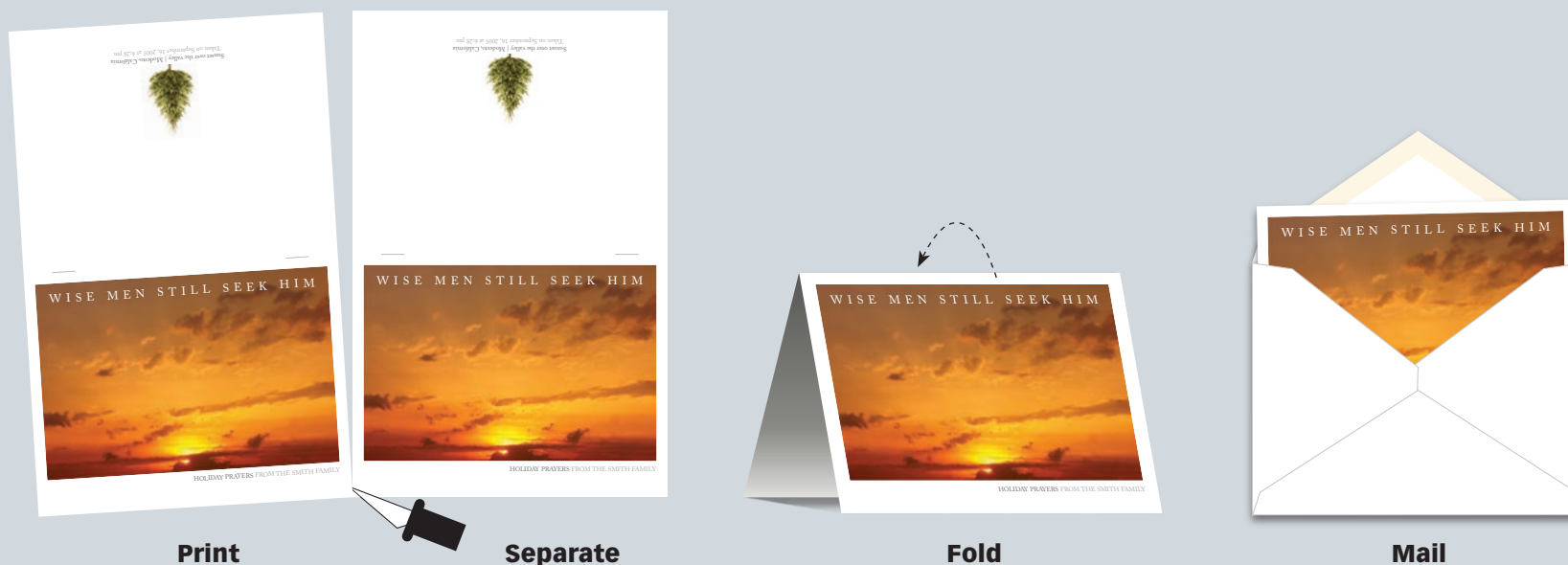

Store-bought holiday cards are attractive but so *commercial*—the Christmas-card “tree” at home looks just like the Hallmark shop at the mall! This year, send a card that can come only from *you*. iStockphoto’s \$1 photo library makes this practical; it puts a world of beautiful images at your fingertips to use alone or with your own photos. The cool part is yours to do:

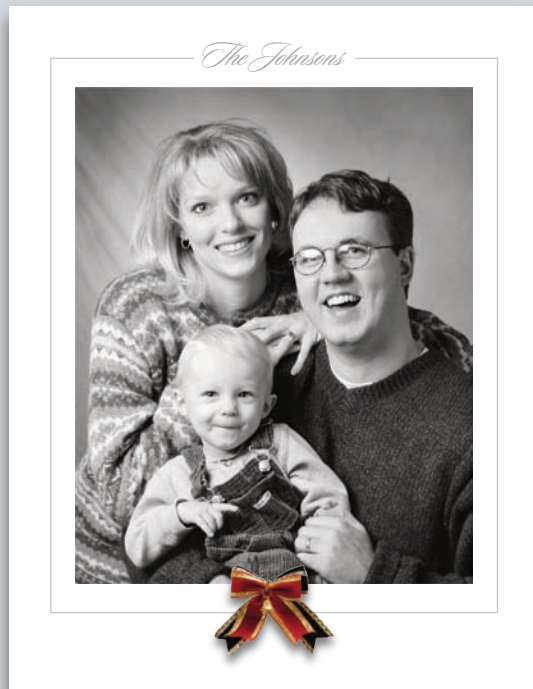

- 1 **Embellish** There is no substitute for a great family portrait. Embellish with a photographic object and a beautiful typeface. Classy.



- 2 **Knock out the background** Delete a busy background, and you'll freshen and focus your image. Add dimension by sending headline to the back!



Dad's in Iraq? Add *news* to your card with caption-style greetings from everyone in the picture! Be brief and use small type; light gray won't steal the scene.





- 3 Pose creatively** Rambunctious kids will have fun posing in a circle! Cockeyed portrait lends itself to an enthusiastic, *askew* layout!

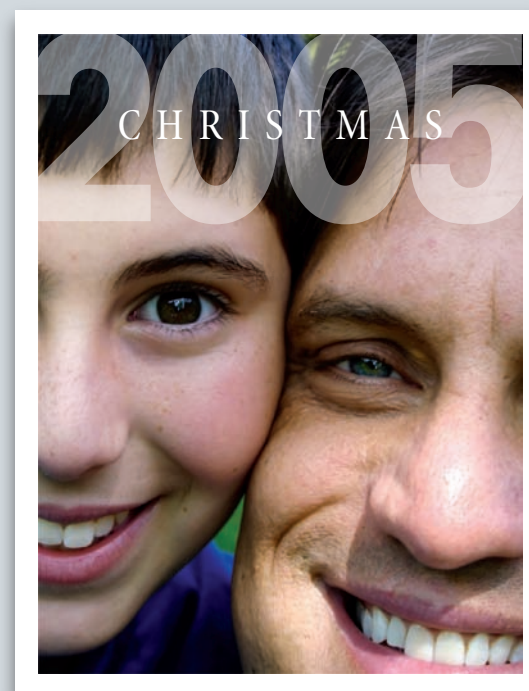

- 4 Crop radically** Only true friends will let you get this close! It's a bold technique and fun to try. White type centered atop translucent year is quietly powerful.



- 5 Use an object** A photographic object makes a beautiful card easily. Keep it simple, and personalize each greeting.

White makes it work

No matter what size or shape the space, an object alone in a field of white gets seen. Here, the script typeface is totally different in shape, texture and style, thus complementary.



- 6 Use an illustration or dingbat** Whimsical artwork and scribbly type make a happy card! Centered presentation lends formality and style.

Use beautiful type

Calligraphic typography says Christmas! Use alone or embellish with an object or border. Here, dark and light colors contrast beautifully on the neutral-value background.





7 Create a theme Design a series of cards on a single topic. Keep type and layout repetitive throughout. Use scenics, flowers, abstracts, a personal portfolio. Expresses your words in several ways. Also nice when you can't decide on a single image.



Keep the type quiet Uppercase headline *force-justified* spans the card and makes a sophisticated statement; soft color is sampled from the photo. On the back, finish with a caption, comment or logo just like Hallmark does! Note alignment with the front.

Front



Back

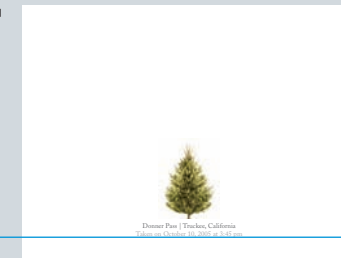



Card & envelope specs

Card size Standard picture frame **Envelope** A7 (A-Style)

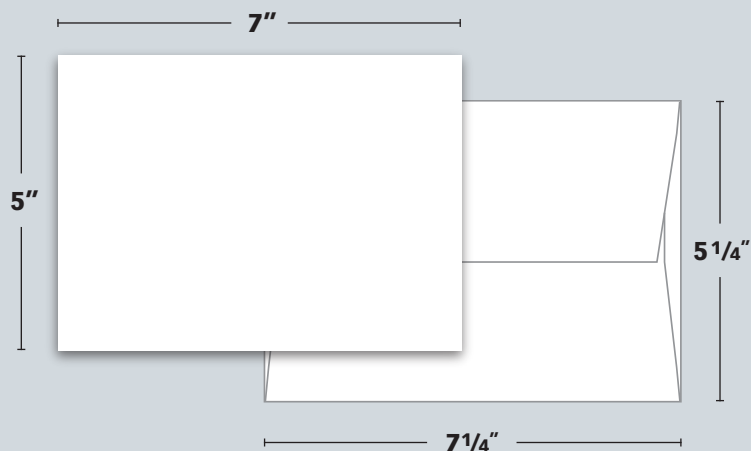

Card size Standard snapshot **Envelope** A6 (6 Baronial)

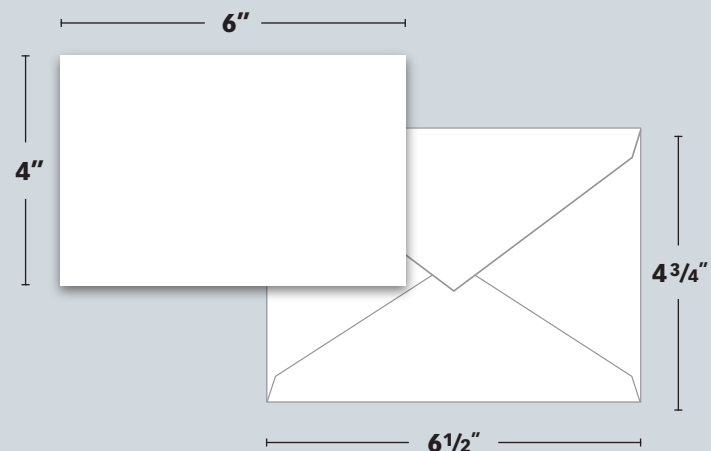

Card size Letter sheet quartered **Envelope** A2 (5 1/2 Baronial)

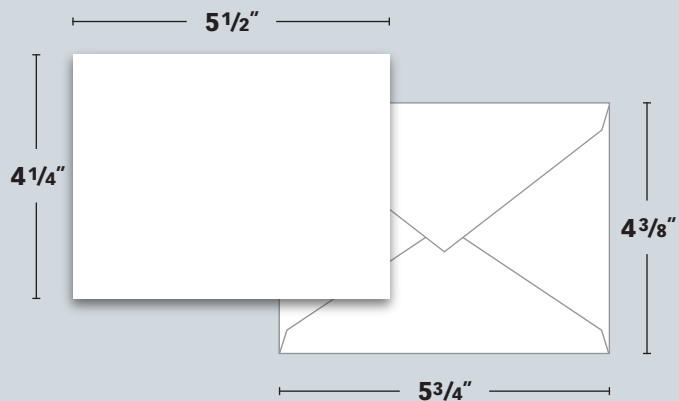

Card size Letter sheet divided in thirds **Envelope** #9

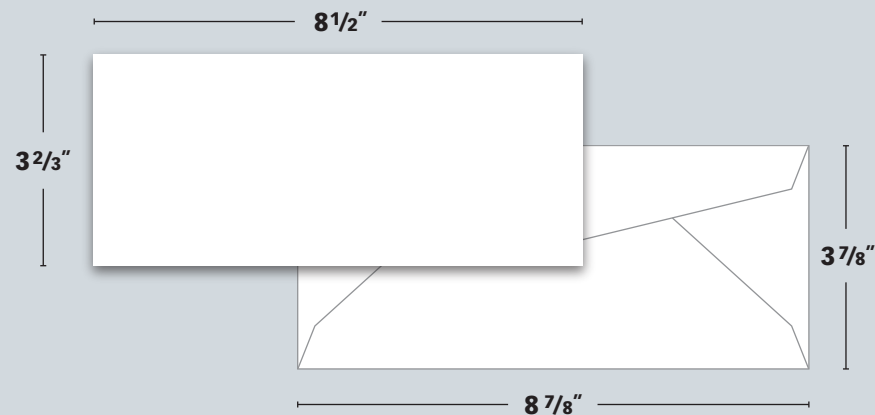



Article resources



Typefaces

- 1 [Sloop Script One](#) | 20 pt
- 2 [Block Berthold Extra Cond](#) | 65 pt
- 3 [Utopia Black](#) | 8 pt
- 4 [Utopia Regular](#) | 6.5 pt
- 5 [ITC Avant Garde Gothic Bold Cond](#) | 158 pt
- 6 [Minion Pro Cond Subhead](#) | 27 pt
- 7 (a-c) [Zipty Do Regular](#) | a) 40 pt
b) 20 pt, c) 12 pt

Colors

- 10** C0 M100 Y80 K30
- 11** C0 M50 Y40 K15
- 12** C45 M0 Y50 K15
- 13** C0 M0 Y0 K45
- 14** C90 M0 Y100 K30
- 15** C0 M0 Y0 K50

Images

- 8 (a-f) [iStockphoto.com](#) | [a](#) [b](#) [c](#) [d](#) [e](#) [f](#)
- 9 (a-b) [Rubberball.com](#) | [a](#) [b](#)



Article resources

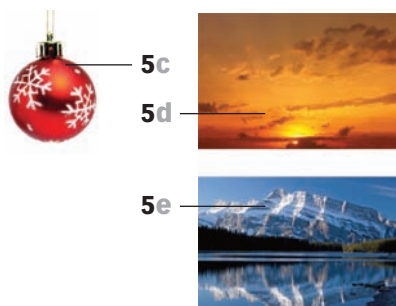
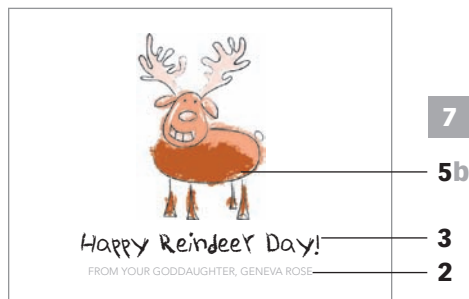

Typefaces

- 1 [Carpenter ICG](#) | 32 pt
- 2 [Avenir 35 Light](#) | 9 pt
- 3 [Kid Type Crayon](#) | 13.5 pt
- 4 (a-b) [Adobe Caslon](#) | a) 14.5 pt, b) 8 pt

Images

- 5 (a-f) [iStockphoto.com](#) | [a](#) [b](#) [c](#) [d](#)
[e](#) [f](#)

Colors

- 6 C35 M55 Y70 K60
- 7 C0 M0 Y0 K40
- 8 C45 M30 Y20 K0
- 9 C0 M0 Y0 K70



Subscribe to Before & After

Did you learn from this article? Subscribe, and become a more capable, confident designer for pennies per article. To learn more, go to <http://www.bamagazine.com/Subscribe>

E-mail this article

To pass along a free copy of this article to others, [click here](#).

Join our e-list

To be notified by e-mail of new articles as they become available, go to <http://www.bamagazine.com/email>

Before & After magazine

Before & After has been sharing its practical approach to graphic design since 1990. Because our modern world has made designers of us all (ready or not), Before & After is dedicated to making graphic design understandable, useful and even fun for everyone.

John McWade Publisher and creative director

Gaye McWade Associate publisher

Vincent Pascual Staff designer

Dexter Mark Abellera Staff designer

Design advisor **Gwen Amos**

Before & After magazine

323 Lincoln Street, Roseville, CA 95678

Telephone 916-784-3880

Fax 916-784-3995

E-mail mailbox@bamagazine.com

www <http://www.bamagazine.com>

Copyright ©2005 Before & After magazine, ISSN 1049-0035. All rights reserved

You may pass this article around, but you may not alter it, and you may not charge for it. You may quote brief sections for review. If you do this, please credit Before & After magazine, and [let us know](#). To feature free Before & After articles on your Web site, [please contact us](#). For permission to include all or part of this article in another work, [please contact us](#).

Before & After is made to fit your binder

Before & After articles are intended for permanent reference. All are titled and numbered.

For the current table of contents, [click here](#). To save time and paper, a paper-saver format of this article, suitable for one- or two-sided printing, is provided on the following pages.

For presentation format

[Print: \(Specify pages 1–10\)](#)



Print

Format: Landscape
Page Size: Fit to Page



Save

Presentation format or
Paper-saver format

For paper-saver format

[Print: \(Specify pages 12–16\)](#)

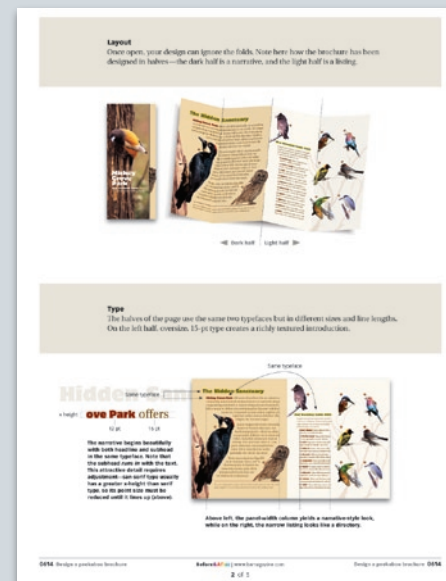

Design your own

Christmas cards



Desktop printers and a \$1 photo library have made it easy to send beautiful, *personal* greetings!



Print

Separate



Fold



Mail

Store-bought holiday cards are attractive but so *commercial*—the Christmas-card “tree” at home looks just like the Hallmark shop at the mall! This year, send a card that can come only from *you*. iStockphoto’s \$1 photo library makes this practical; it puts a world of beautiful images at your fingertips to use alone or with your own photos. The cool part is yours to do:



1 Embellish There is no substitute for a great family portrait. Embellish with a photographic object and a beautiful typeface. *Classic.*

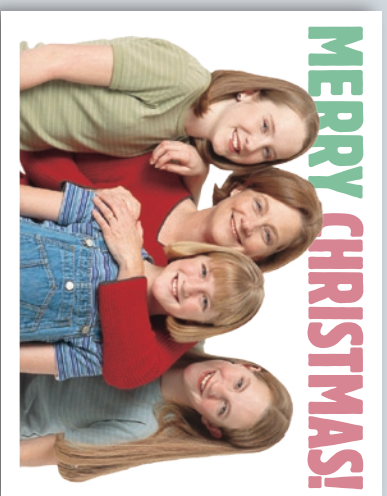

2 Knock out the background Delete a busy background, and you'll freshen and focus your image. Add dimension by sending headline to the back!

Dad's in Iraq? Add news to your card with caption-style greetings from everyone in the picture! Be brief and use small type; light gray won't steal the scene.



3 Pose creatively Rambunctious kids will have fun posing in a circle! Cockeyed portrait lends itself to an enthusiastic, askew layout!

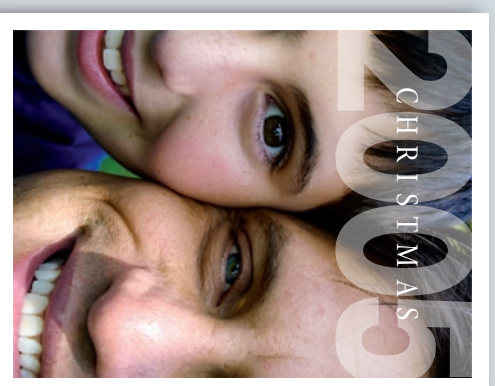

4 Crop radically Only true friends will let you get this close! It's a bold technique and fun to try. White type centered atop translucent year is quietly powerful.



5 Use an object A photographic object makes a beautiful card easily. Keep it simple, and personalize each greeting.

White makes it work
No matter what size or shape the space, an object alone in a field of white gets seen. Here, the script typeface is totally different in shape, texture and style, thus complementary.



6 Use an illustration or dingbat Whimsical artwork and scribbly type make a happy card! Centered presentation lends formality and style.

Use beautiful type
Calligraphic typography says Christmas! Use alone or embellish with an object or border. Here, dark and light colors contrast beautifully on the neutral-value background.

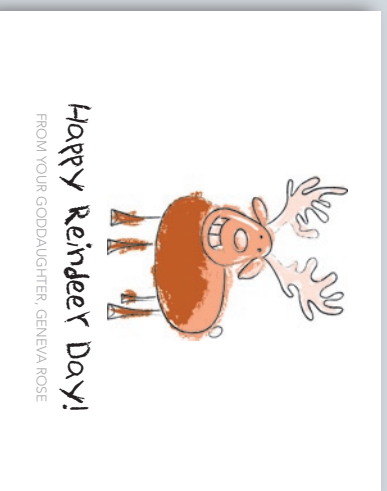

7 Create a theme Design a series of cards on a single topic. Keep type and layout repetitive throughout. Use scents, flowers, abstracts, a personal portfolio. Expresses your words in several ways. Also nice when you can't decide on a single image.



Keep the type quiet Uppercase headline *force-justified* spans the card and makes a sophisticated statement; soft color is sampled from the photo. On the back, finish with a caption, comment or logo just like Hallmark does! Note alignment with the front.

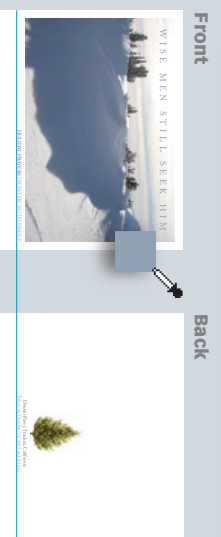

Article resources



10
11
12
13

- Typefaces**
- 1 [Sloop Script One](#) | 20 pt
 - 2 [Block Berthold Extra Cond](#) | 65 pt
 - 3 [Utopia Black](#) | 8 pt
 - 4 [Utopia Regular](#) | 6.5 pt
 - 5 [ITC Avant Garde Gothic Bold Cond](#) | 158 pt
 - 6 [Minion Pro Cond Subhead](#) | 27 pt
 - 7 (a-c) [Zippy Dd Regular](#) | a) 40 pt
b) 20 pt, c) 12 pt

- Colors**
- 10 C0 M100 Y80 K30
 - 11 C0 M50 Y40 K15
 - 12 C45 M0 Y50 K15
 - 13 C0 M0 Y0 K45
 - 14 C90 M0 Y100 K30
 - 15 C0 M0 Y0 K50



10
14
15

- Images**
- 8 (a-f) [iStockphoto.com](#) | a b c d e f
 - 9 (a-b) [Rubberball.com](#) | a b

Article resources

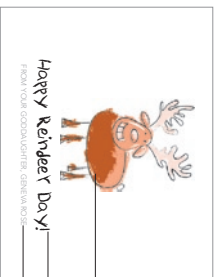

7
5b
3
2

- Typefaces**
- 1 [Carpenter ICG](#) | 32 pt
 - 2 [Avenir 35 Light](#) | 9 pt
 - 3 [Kid Type Crayon](#) | 13.5 pt
 - 4 (a-b) [Adobe Caslon](#) | a) 14.5 pt, b) 8 pt

- Colors**
- 6 C35 M55 Y70 K60
 - 7 C0 M0 Y0 K40
 - 8 C45 M30 Y20 K0
 - 9 C0 M0 Y0 K70

- Images**
- 5 (a-f) [iStockphoto.com](#) | a b c d e f

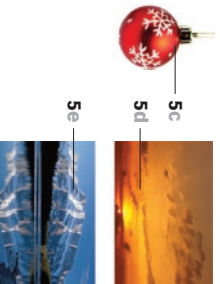

4a
7
8
9
5f
4b

Subscribe to Before & After

Did you learn from this article? Subscribe, and become a more capable, confident designer for pennies per article. To learn more, go to <http://www.bamagazine.com/Subscribe>

E-mail this article

To pass along a free copy of this article to others, [click here](#).

Join our e-list

To be notified by e-mail of new articles as they become available, go to <http://www.bamagazine.com/email>

Before & After magazine

Before & After has been sharing its practical approach to graphic design since 1990. Because our modern world has made designers of us all (ready or not), Before & After is dedicated to making graphic design understandable, useful and even fun for everyone.

John McWade Publisher and creative director

Gaye McWade Associate publisher

Vincent Pascual Staff designer

Dexter Mark Abellera Staff designer

Design advisor **Gwen Amos**

Before & After magazine

323 Lincoln Street, Roseville, CA 95678

Telephone 916-784-3880

Fax 916-784-3995

E-mail mailbox@bamagazine.com

www <http://www.bamagazine.com>

Copyright ©2005 Before & After magazine, ISSN 1049-0035. All rights reserved

You may pass this article around, but you may not alter it, and you may not charge for it. You may quote brief sections for review. If you do this, please credit Before & After magazine, and [let us know](#). To feature free Before & After articles on your Web site, [please contact us](#). For permission to include all or part of this article in another work, [please contact us](#).